

# RP1000 Integrated Effects Switching System

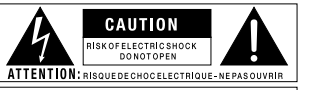

**Digitech**  
by HARMAN

## Owner's Manual



**ATTENTION:** RISQUE DE CHOC ELECTRIQUE - NE PAS OUVRI

**WARNING:** TO REDUCE THE RISK OF FIRE OR ELECTRIC SHOCK DO NOT EXPOSE THIS EQUIPMENT TO RAIN OR MOISTURE

The symbols shown above are internationally accepted symbols that warn of potential hazards with electrical products. The lightning flash with arrowpoint in an equilateral triangle means that there are dangerous voltages present within the unit. The exclamation point in an equilateral triangle indicates that it is necessary for the user to refer to the owner's manual.

These symbols warn that there are no user serviceable parts inside the unit. Do not open the unit. Do not attempt to service the unit yourself. Refer all servicing to qualified personnel. Opening the chassis for any reason will void the manufacturer's warranty. Do not get the unit wet. If liquid is spilled on the unit, shut it off immediately and take it to a dealer for service. Disconnect the unit during storms to prevent damage.

**ELECTROMAGNETIC COMPATIBILITY**

This device complies with part 15 of the FCC Rules and the Product Specifications noted on the **Declaration of Conformity**. Operation is subject to the following two conditions:

- this device may not cause harmful interference, and
- this device must accept any interference received, including interference that may cause undesired operation.

Operation of this unit within significant electromagnetic fields should be avoided.

- use only shielded interconnecting cables.

If you want to dispose this product, do not mix it with general household waste. There is a separate collection system for used electronic products in accordance with legislation that requires proper treatment, recovery and recycling.  
Private household in the 25 member states of the EU in Switzerland and Norway may return their used electronic products free of charge to designated collection facilities or to a retailer (if you purchase a similar new one).  
For countries not mentioned above, please contact your local authorities for a correct method of disposal.  
By doing so you will ensure that your disposed product undergoes the necessary treatment, recovery and recycling and thus prevent potential negative effects on the environment and human health.

**WARNING FOR YOUR PROTECTION  
READ THE FOLLOWING:**

KEEP THESE INSTRUCTIONS

HEED ALL WARNINGS

FOLLOW ALL INSTRUCTIONS

THE APPARATUS SHALL NOT BE EXPOSED TO DRIPPING OR SPLASHING LIQUID AND NO OBJECT FILLED WITH LIQUID, SUCH AS VASES, SHALL BE PLACED ON THE APPARATUS

CLEAN ONLY WITH A DRY CLOTH.

DO NOT BLOCK ANY OF THE VENTILATION OPENINGS. INSTALL IN ACCORDANCE WITH THE MANUFACTURER'S INSTRUCTIONS.

DO NOT INSTALL NEAR ANY HEAT SOURCES SUCH AS RADIATORS, HEAT REGISTERS, STOVES, OR OTHER APPARATUS (INCLUDING AMPLIFIERS) THAT PRODUCE HEAT.

ONLY USE ATTACHMENTS/ACCESSORIES SPECIFIED BY THE MANUFACTURER.

UNPLUG THIS APPARATUS DURING LIGHTNING STORMS OR WHEN UNUSED FOR LONG PERIODS OF TIME.

Do not defeat the safety purpose of the polarized or grounding-type plug. A polarized plug has two blades with one wider than the other. A grounding type plug has two blades and a third grounding prong. The wide blade or third prong are provided for your safety. If the provided plug does not fit your outlet, consult an electrician for replacement of the obsolete outlet.

Protect the power cord from being walked on or pinched particularly at plugs, convenience receptacles, and the point where they exit from the apparatus.

Refer all servicing to qualified service personnel. Servicing is required when the apparatus has been damaged in any way, such as power-supply cord or plug is damaged, liquid has been spilled or objects have fallen into the apparatus, the apparatus has been exposed to rain or moisture, does not operate normally, or has been dropped.

**MAINS DISCONNECT:** The plug shall remain readily operable. For rack-mount or installation where plug is not accessible, an all-pole mains switch with a contact separation of at least 3 mm in each pole shall be incorporated into the electrical installation of the rack or building.

**DECLARATION OF CONFORMITY**

Manufacturer's Name: Harman Music Group  
 Manufacturer's Address: 8760 S. Sandy Parkway  
 Sandy, Utah 84070, USA

declares that the product:

Product name: RP 1000

Product option: all (requires Class II power adapter that conforms to the requirements of EN60065, EN60742, or equivalent.)

conforms to the following Product Specifications:

- Safety: IEC 60065 -01+Amd 1
- EMC: EN 55022:2006  
 EN 55024:1998  
 FCC Part 15

Supplementary Information:

The product herewith complies with the requirements of the:  
 Low Voltage Directive 2006/95/EC  
 EMC Directive 2004/108/EC.  
 RoHS Directive 2002/95/EC  
 WEEE Directive 2002/96/EC  
 EC Regulation 278/2009

With regard to Directive 2005/32/EC and EC Regulation 1275/2008 of 17 December 2008, this product is designed, produced, and classified as Professional Audio Equipment and thus is exempt from this Directive.

Director, Engineering  
 Signal Processing  
 8760 S. Sandy Parkway  
 Sandy, Utah 84070, USA  
 Date: April 28, 2011

European Contact: Your local DigiTech Sales and Service Office or

Harman Music Group  
 8760 South Sandy Parkway  
 Sandy, Utah  
 84070 USA  
 Ph: (801) 566-8800  
 Fax: (801) 568-7583



# Table of Contents

## Section One - Introduction ..... I

Getting Acquainted.....	I
Included Items.....	I
About the RP1000.....	I
Preset Mode and Pedalboard Mode.....	I
Bypass.....	I
Amp/Cabinet Bypass.....	2
Tuner.....	2
Tone Library (Knob 1).....	2
Effects Library (Knob 2).....	2
Effects Level (Knob 3).....	2
Amp Gain/Effect Parameter (Knob 4).....	3
Amp Level/Effect Parameter (Knob 5).....	3
Master Level (Knob 6).....	3
X-Edit™ Editor/Librarian.....	3
Presets.....	3
Create Your Sound in Three Easy Steps.....	3
A Guided Tour of the RP1000.....	4
Front Panel.....	4
Rear Panel.....	7
Getting Started.....	8
Making Connections.....	8
Amp/Cabinet Bypass.....	8
Amp Loop.....	8
Stomp Loop.....	8
Connection Setups.....	9
Applying Power.....	14

## Section Two - Editing Functions..... 14

Preset Mode and Pedalboard Mode.....	14
Editing/Creating Presets.....	15
Editing Amp/Cabinet Models.....	15
Amp/Cabinet Bypass.....	15
Storing/Copying/Naming a Preset.....	16

## Section Three - Effects and Parameters ..... 17

About the Effects.....	17
Effect Definitions.....	17
Wah.....	17
Compressor.....	17
Distortion.....	18
Amplifier.....	20
EQ.....	22
Noise Gate/Auto Swell.....	22
Chorus/FX.....	22
Chorus.....	22
Flanger.....	23
Phaser.....	24
Vibrato.....	24
Rotary Speaker.....	24
VibroPan.....	25
Unicord Uni-Vibe™.....	25
Tremolo/Panner.....	25
Envelope Filter.....	26
DOD FX25.....	26
AutoYa™.....	26
Ya Ya™.....	26
SynthTalk™.....	26
Step Filter.....	27
Sample Hold.....	27
DigiTech Whammy®.....	27
Pitch Shift.....	28
Detune.....	28

Harmony Pitch Shifting.....	28
Boss® OC-2 Octaver™.....	29
Delay.....	29
Reverb.....	30

## Section Four - Other Functions..... 31

Expression Pedal.....	31
Footswitch Assign.....	31
LFOs.....	31
Wah Min/Max.....	32
Expression Update.....	32
Factory Reset.....	32
Expression Pedal Calibration.....	32
Preset Level.....	33
Bypass.....	33
Looper.....	33
Tuner.....	35
USB Setup.....	35

## Section Five - RP1000 Effects

### Descriptions ..... 37

Wahs.....	37
Compressors.....	37
Noise Gates.....	37
EQ.....	38
Chorus Stompbox Models.....	38
Flanger.....	38
Phasers.....	39
Pitch.....	39
Vibrato / Rotary.....	40
Tremolo.....	40
Envelope / Special.....	41
Delays.....	41
Reverbs.....	42
Distortions.....	42
Amps.....	44
Cabinets.....	48

## Section Six - Appendix..... 50

Specifications.....	50
Tone Library.....	51
Effects Library.....	51

## Warranty

We at **DigiTech®** are very proud of our products and back up each one we sell with the following warranty:

1. The warranty registration card must be mailed within ten days after purchase date to validate this warranty.
2. DigiTech warrants this product, when used solely within the U.S., to be free from defects in materials and workmanship under normal use and service.
3. DigiTech liability under this warranty is limited to repairing or replacing defective materials that show evidence of defect, provided the product is returned to DigiTech WITH RETURN AUTHORIZATION, where all parts and labor will be covered up to a period of one year. A Return Authorization number may be obtained from DigiTech by telephone. The company shall not be liable for any consequential damage as a result of the product's use in any circuit or assembly.
4. Proof-of-purchase is considered to be the burden of the consumer.
5. DigiTech reserves the right to make changes in design, or make additions to, or improvements upon this product without incurring any obligation to install the same on products previously manufactured.
6. The consumer forfeits the benefits of this warranty if the product's main assembly is opened and tampered with by anyone other than a certified DigiTech technician or, if the product is used with AC voltages outside of the range suggested by the manufacturer.
7. The foregoing is in lieu of all other warranties, expressed or implied, and DigiTech neither assumes nor authorizes any person to assume any obligation or liability in connection with the sale of this product. In no event shall DigiTech or its dealers be liable for special or consequential damages or from any delay in the performance of this warranty due to causes beyond their control.

**NOTE:** The information contained in this manual is subject to change at any time without notification. Some information contained in this manual may also be inaccurate due to undocumented changes in the product or operating system since this version of the manual was completed. The information contained in this version of the owner's manual supersedes all previous versions.



# Section One - Introduction

## Getting Acquainted

Congratulations on your purchase of the RP1000. The RP1000 Integrated Effects Switching System takes your tone to the next level giving you the control that you need over your external amp and stompboxes while packing in the power of a multi-effects processor. Use the RP1000 to control and spice up your tone without any compromises. The RP1000's vast pallet of stompboxes, effects, amps and cabinets allow you to get any sound imaginable and then some. Easily dial up a sound using the Tone and Effects Library knobs. You will appreciate the tone and dynamic interaction of each of the amps, stompboxes, and effects with your system. Add USB support for computer recording and you have the RP1000: the key to unlock your creative potential.

## Included Items

Before you get started, please make sure that these things are in the box:

- RP1000
- Cubase LE 4 DVD
- Power Supply
- Warranty Card

We took a lot of care when we put this product together. Everything should be included and in perfect working order. If anything's missing, contact the factory at once. Help us get to know you by filling out the warranty card and sending it to us, or register online at [www.digitech.com](http://www.digitech.com). You'll be glad you did if you have any questions about your RP1000 down the road.

## About the RP1000

Do yourself a favor and read the next couple pages before you start playing with your new RP1000. It'll help you get the most out of it without having to read the whole manual.

### Preset Mode and Pedalboard Mode

There are two different ways to use the footswitches with the presets: Preset Mode and Pedalboard Mode. Push the Pedalboard button (just to the right of the knobs below the Display) to toggle between these two modes.

#### Preset Mode

In Preset mode (Pedalboard button is off), each of the 10 numbered footswitches loads a preset, and you can't turn individual models on or off with the footswitches. The Up/Down footswitches select banks of 10 presets.

#### Pedalboard Mode

In Pedalboard mode, footswitches 1-5 select presets, and footswitches 6-10 act like pedals on a pedalboard. That means you can turn the distortion, chorus, etc. on and off within each preset. The first time you power up the RP1000 when you take it out of the box (or after doing a factory restore), it's in Pedalboard mode.

The RP1000 remembers which mode you're in when you turn it off, and keeps it in that mode when you turn it back on.

## Bypass

You can bypass all the internal amps and effects in the RP1000 by stepping on the currently active preset's footswitch. In bypass mode, your guitar's clean signal comes through without any processing. To exit bypass mode and re-activate the preset you were in, just step the same footswitch again. To exit bypass mode and activate another preset, step on a different footswitch.

If you're using the Amp Loop and/or the Stomp Loop when you go into bypass mode, any devices connected to the Amp Loop and Stomp Loop are still active. So you can use bypass to kill all the effects in the RP1000 without bypassing your amp/preamp connected to the Amp Loop.

## Amp/Cabinet Bypass

You can also turn off the internal amps and cabinets for all the presets in the RP1000. This is really useful when you just want to add effects processing to your own core amplifier sound. So basically the RP1000 becomes a straight multi-effects box when you do this, and only Wah, Compressor, Distortion, Equalizer, Noise Gate, Chorus/FX, Delay, and Reverb are used.

To bypass amp/cabinet modeling in all presets, press the **Amp/Cabinet Bypass** button. When that button is lit, amp/cabinet modeling is bypassed in all presets.

You can use amp/cabinet bypass in Preset or Pedalboard mode.

## Tuner

The RP1000's built-in tuner lets you quickly and easily tune your guitar, even on a dark stage. Just press and hold the currently active preset's **Footswitch** for 2 seconds. The Display briefly shows *BYPASS* then *TUNER* to let you know you're in Tuner mode. To begin tuning, play a note on your guitar (a harmonic at the 12th fret usually works best). The Numeric Display shows the note being played. Arrows on the right mean the note is sharp and should be tuned down. Arrows on the left mean the note is flat and should be tuned up. A left and a right arrow in the center mean the note is in tune. The Expression Pedal controls the guitar volume while tuning. Exit tuner mode by pressing any **Footswitch**.

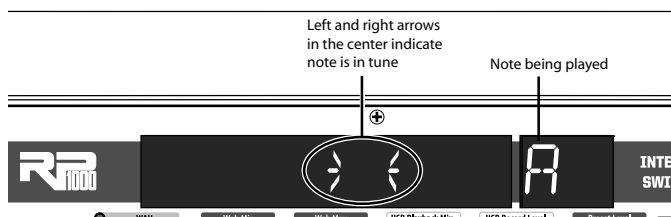

If you use an alternate tuning, like down a half-step or drop D, you can still use the tuner as if you were in standard tuning. Just go into Tuner mode and change your tuning reference. The default setting is standard tuning, where  $A=440$  Hz (displayed as  $A=440$ ). But when you're in Tuner mode, you can rotate **Knob 1** to pick an alternate tuning. These include  $A = A\flat$ ,  $A = G$ ,  $A = G\flat$ , and tuning references  $A=427 - A=453$ .

## Tone Library (Knob 1)

This is one of the RP1000's coolest features. In Pedalboard and Preset modes, you turn this knob to pick from a list of amp tones like Blues or Metal or Country. Each one has different Compressor, Distortion, Amp/Cabinet type, EQ, and Noise Gate settings, but you don't have to mess with any of those settings if you don't want to, they just load up automatically when you pick a tone from the library. If you're into it, you **can** go ahead and refine the sound by editing the preset (see *Editing/Creating Presets* on page 15), but the thing is you don't have to. The Tone Library doesn't change the Chorus/FX, Delay or Reverb, so you can experiment with different amp styles quickly with the current effect chain. When in Amp/Cabinet Bypass Mode, the amplifiers are bypassed, so only the distortion and overdrive stompboxes are providing distortion.

## Effects Library (Knob 2)

This knob works hand-in-hand with the Tone Library knob. In Pedalboard and Preset modes, this knob selects from a variety of post-amplifier effect chains (Chorus, Chorus + Delay, Delay + Reverb, etc.). And just like with the Tone library, you can edit the preset if you want to (see *Editing/Creating Presets* on page 15), but you don't have to. Changing between different Effects Library selections doesn't change the Compressor, Distortion, Amp/Cabinet types, EQ, and Noise Gate settings, so you can experiment with different effect chains quickly with the current amp tone.

## Effects Level (Knob 3)

In Pedalboard and Preset modes, this knob changes the relative level of the post-amp effects (Chorus/FX, Delay, and Reverb). It's like an effects mix control, where turning it clockwise increases the level of these effects and turning it counter-clockwise decreases the level of these effects.

### **Amp Gain/Effect Parameter (Knob 4)**

This knob adjusts the Gain (distortion) for the selected Amp (not available for Acoustic) and is also used to adjust parameters of other effects in the matrix. The amplifier and cabinets can't be adjusted when the Amp/Cabinet Bypass button is enabled.

### **Amp Level/Effect Parameter (Knob 5)**

This knob adjusts the Level (volume) of the selected amp and adjusts other effect parameters in the matrix. Amp Level can't be adjusted when the Amp/Cabinet Bypass button is enabled.

### **Master Level (Knob 6)**

This knob controls the overall output volume of all of the RPI000's presets and adjusts other effect parameters in the matrix.

### **X-Edit™ Editor/Librarian**

You can edit your RPI000 with your computer, using the X-Edit™ Editor/Librarian, which you can download from [www.digitech.com](http://www.digitech.com).

### **Presets**

Presets are named and numbered locations of programmed sounds which reside in the RPI000 (in case you didn't know). You load Presets with the Footswitches (see *Preset Mode and Pedalboard Mode* on page 14 for more information about that). The active effects in each preset are indicated by lighted LEDs in the Effect Matrix, and if you're in Pedalboard mode, the LEDs over footswitches 6-10 show you which of those effects are on or off. The RPI000 comes with 100 User presets (1-00) and 100 Factory presets (F1-F00). You can save changes to the User presets, but not the Factory presets. From the factory, the 100 User presets are exact duplicates of the 100 Factory presets. That way you can create your own presets without losing the sounds that came with the RPI000.

## **Create Your Sound in Three Easy Steps**

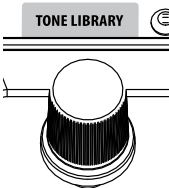
- 

**1. Tone Library**  
Select one of 40 different tones from rock, metal, blues, country, and more. The tones consist of a combination of Compressor, Distortion Stompbox, Amplifier/Cabinet, EQ, and Noise Gate.  
For a complete list of available tones, see page 51.
- 

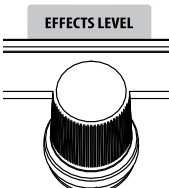
**2. Effects Library**  
Select one of 40 different effects chains. The effects consist of a combination of Chorus/FX, Delay, and Reverb.  
For a complete list of available effects chains, see page 51.
- 

**3. Effects Level**  
Adjust the overall level of the post-amp effects to your liking.

To make further edits, refer to page 15. To store the preset, refer to page 16.

## A Guided Tour of the RP1000 Front Panel

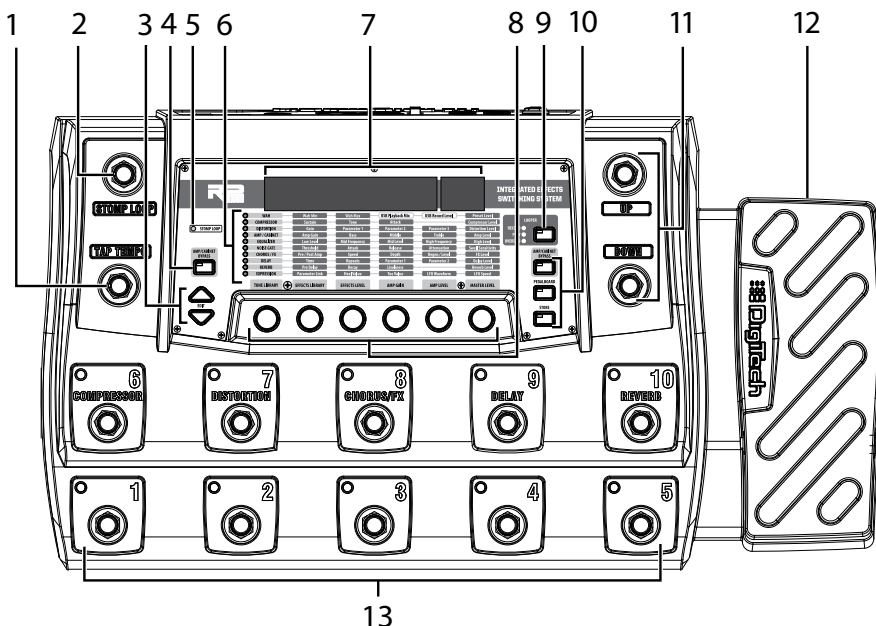

### 1. Tap Tempo Footswitch

Step on this footswitch repeatedly in time with your music to get the delay to sync up with the music's rhythm.

### 2. Stomp Loop Footswitch

This footswitch enables and disables the mono stompbox effects loop.

### 3. Edit Up/Down Buttons

These buttons navigate up and down the rows of the matrix for editing presets.

### 4. Amp Loop Button

This button enables and disables the external Amp/Preamp loop. The button lights when the Amp/Preamp loop is active. If no connections are made to the loop, **NO LOOP** appears in the display briefly when the button is engaged or disengaged.

### 5. Stomp Loop LED

This LED lights when the Stomp Loop is activated using the **Stomp Loop** footswitch. When the LED is off, the Stomp Loop is inactive. Note that the Stomp Loop button's LED turns red when its position is pre amp model and amp loop, and green when it's post amp model and amp loop.

### 6. Effects Matrix

The matrix provides information regarding the current preset and parameter edit functions. In Performance mode, the LEDs running down the left side of the Matrix provide a visual indication of which effects are in use for the selected preset. While editing a preset, the LEDs indicate that the Effect row is selected for editing.

### 7. Displays

The RP1000 has two sets of displays. The 8 character alpha-numeric display shows preset names, bank names, and effects names while editing. The 2 character numeric display shows preset numbers and effects parameters while editing and shows the note being tuned when the Tuner is enabled.



## 8. Knobs 1-6 (From left to right)

These six knobs perform various functions, depending on which mode is currently active and what (if anything) is being edited. The functions are listed below:

### Tone Library (Knob 1)

1. In Performance mode, this knob selects from a library of preset amp tones.
2. When editing a preset, this knob changes the Amp or Effect model for the selected row and pressing the knob will turn the effect row on or off. When editing an Effect row, press this knob to turn the effect on or off. When editing the Amp/Cabinet row, pressing this knob will switch between editing the amp model or the cabinet model.
3. When the Expression row is selected, this knob selects the Expression Pedal, LFO 1, and LFO 2 parameter links, footswitch 6-10 assignments, Wah pedal range, Expression Pedal update, and Stomp Loop position.

\*NOTE: the assignments selected for footswitches 6-10 are only available when the Pedal-board button is active.

### Effects Library (Knob 2)

1. In Performance mode, this knob selects from a library of preset effect chains.
2. When editing a preset, this knob modifies the parameter listed in the column directly above it for the selected Effect row.
3. When the Expression row is selected, this knob selects which parameter is assigned to the Expression Pedal, footswitches 6-10\*, and LFO1 or LFO2.

\*NOTE: the assignments selected for footswitches 6-10 are only available when the Pedal-board button is active.

### Effects Level (Knob 3)

1. In Performance mode, this knob adjusts the overall level of post amp model effects (Chorus/FX, Delay, and Reverb).
2. When editing a preset, this knob modifies the parameter listed in the column directly above it for the selected Effect row.
3. When the Expression row is selected, this knob selects the heel value for the parameter linked to the Expression Pedal or the off state are parameters assigned to footswitches 6-10\*.

\*NOTE: the assignments selected for footswitches 6-10 are only available when the Pedal-board button is active.

### Amp Gain (Knob 4)

1. In Performance mode, this knob adjusts the Amp Gain (distortion) for the selected Amp model.
2. When editing a preset, this knob modifies the parameter listed in the column directly above it for the selected Effect row. This knob also is used to adjust the RP/USB mix when the RP1000 is connected to a computer and using recording software. Just select the Wah row to adjust this parameter when USB is connected to the RP1000.
3. When the Expression row is selected, this knob selects the toe value for the parameter linked to the Expression Pedal Expression Pedal or the on state are parameters assigned to footswitches 6-10\*.

\*NOTE: the assignments selected for footswitches 6-10 are only available when the Pedal-board button is active.

### Amp Level (Knob 5)

1. In Performance mode, this knob adjusts the Amp Level (volume) of the selected Amp model.
2. When editing a preset, this knob modifies the parameter listed in the column directly above it for the selected Effect row. This knob is also used to adjust the USB Record Level when the RP1000 is connected to a computer and using recording software. Just

3. select the Wah row to adjust this parameter when USB is connected to the RP1000.
3. When the Expression row is selected, this knob selects the LFO waveform. LFO 1 or LFO 2 must first be selected with Knob 1 for this parameter to be available.

### Master Volume (Knob 6)

1. In Performance mode, this knob adjusts the output level of the RP1000.
2. When editing a preset, this knob modifies the parameter listed in the column directly above it for the selected Effect row.
3. When the Expression row is selected, this knob sets the LFO speed. LFO 1 or LFO 2 must first be selected with Knob 1 for this parameter to be available.

## 9. Looper Button

This button enables and disables the RP1000's loop phrase sampler. The Looper can be used at any time during RP1000 operation and offers the ability to create mono loop phrases of up to 20 seconds in length. Three LEDs (Record/Play/Overdub) indicate the status of the Looper during use. While the Looper is active, the **Bank Up/Down** footswitches change function to control the Looper record, overdub, playback, and loop clear functions.

## 10. System Buttons

There are three system buttons: AMP/CABINET BYPASS, PEDALBOARD, and STORE.

1. **Amp/Cabinet Bypass** – When this button is lit, amp and cabinet modeling is bypassed in all RP1000 presets
2. **Pedalboard** – When this button is lit, the 5 numbered footswitches turn the effects labeled above them on and off. When the button is not lit, these footswitches select the five presets in the active bank.
3. **Store** – Press this button to begin the store/copy procedure.

## 11. Bank Up/Down Footswitches

These Up/Down footswitches select preset banks. When Pedalboard mode is active, there are 20 banks of 5 presets. When Preset mode is active (Pedalboard button is disabled) there are 10 banks of 10 presets. When the Looper is active, these footswitches control Record, Playback, Overdub, Stop, and Loop Clear functions. Refer to page 33 for more information on using the Looper.

## 12. Expression Pedal

The Expression Pedal provides real-time control of the RP1000's Volume, Wah, or any assigned effect parameter. Almost every parameter is available for Expression Pedal control. The Expression Pedal is equipped with a V-switch that turns on and controls the Wah effect when you apply extra pressure to the toe.

## 13. 1-10 / Effects Footswitches

In Preset Mode, these 10 footswitches select between 10 different presets in the active bank (10 banks of 10 presets). The footswitch LED will light to indicate which preset is active. When Pedalboard mode is active, footswitches 1-5 will select between 5 different presets in the active bank (20 banks of 5 presets) while footswitches 6-10 are used to turn Compressor, Distortion, Chorus/FX, Delay, and Reverb effects on and off. Effects that are on will have their footswitch LED lit.

## Rear Panel

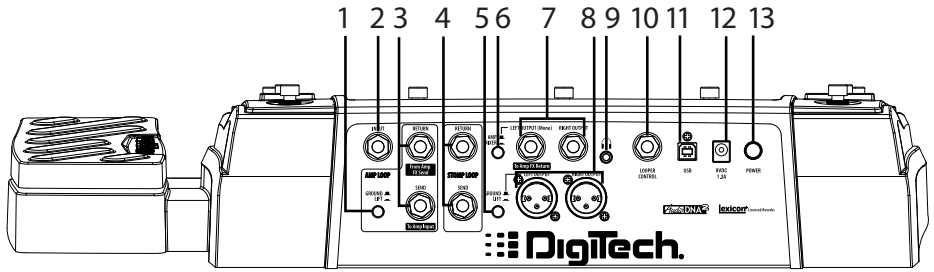

### 1. Amp Loop Ground Lift

This Ground Lift switch can be enabled to help prevent unwanted hum or buzz caused by ground loops between the RP1000 and external amplifiers/preamps.

### 2. Input

High impedance 1/4" instrument input.

### 3. Amp Loop

These 1/4" send and return jacks let you connect to an external preamp or amplifier and use the tone from these components instead of the internal amplifiers of the RP1000. A Ground Lift switch is provided and can be enabled to help prevent unwanted hum or buzz caused by ground loops between the RP1000 and external amplifiers/preamps.

### 4. Stomp Loop

These 1/4" send and return jacks let you connect to an external stompbox effect pedal into one of 2 different positions of the RP1000 effects path.

### 5. Ground Lift Switch

This switch lifts pin 1 from the XLR Mixer Outputs from all ground references. This may be necessary to help solve troublesome ground loops that can cause hum in the system, especially when both XLR and 1/4" outputs are used together.

### 6. Amp/Mixer Switch

This switch optimizes the 1/4" Line Outputs for connecting to either a guitar amp system or directly into the inputs of a mixer.

### 7. 1/4" Line Outputs

These 1/4" outputs can be plugged into a guitar amplifier or into inputs of a mixer or recording device. The front panel Output Level controls the level of these outputs.

### 8. XLR Mixer Outputs

The XLR outputs are designed for connecting to a recording device or mixing console. These outputs always have speaker compensation active as they are intended to be sent into full a range audio system.

### 9. Headphone Output

Connect headphones here. Output optimized for use with headphones having 60 Ohms of impedance or less.

### 10. Looper Control Input

This 1/4" TRS jack allow the optional FS3X footswitch to be connected for remote control of the RP1000's Looper feature.

### 11. USB Jack

The USB jack connects the RP1000 to a computer and provides two purposes. First it is used to provide communication between the RP1000 and the X-Edit editor librarian software. Second, it is used to stream four channels of audio (2 up / 2 back) to and from the computer when using the RP1000 to record via the included Cubase® LE4 recording software or any DAW recording application.

### 12. Power Jack

Connect only the included power adapter here (see Specifications for further information).

### 13. Power Switch

Used to turn the RP1000's power on and off.

## Getting Started

### Making Connections

There are lots of ways to connect the RP1000 to amps, effects, mixers, and other equipment. Before connecting the RP1000 to anything, make sure both your amp and the RP1000 are turned off.

### Amp/Cabinet Bypass

The RP1000 lets you bypass its amp and cabinet tones so you can apply its effects to your own amp/cabinet tone. To bypass the RP1000 amp and cabinet tones in all presets, push the **Amp/Cabinet Bypass** button so it's lit. To utilize the RP1000 amp and cabinet tones, push the **Amp/Cabinet Bypass** button so it's not lit.

### Amp Loop

The RP1000's Amp Loop lets you use an external amplifier or preamp with the RP1000's signal path instead of the RP1000's internal amps and cabinets. You can turn on the Amp Loop with the Amp Loop button on the left side of the matrix. With this button enabled, the external amp or preamp is placed in the signal path around internal amps and cabinets, so the internal amps and cabinets are totally bypassed when the Amp Loop is engaged. To enable the Amp Loop, follow these steps:

1. Press the **Amp Loop** button on the left side of the effects matrix. When the LED on the Amp Loop button is lit, the Amp Loop is enabled and the connected device is now in the RP1000's effects chain. Internal Amp/Cabinets are basically bypassed when the Amp Loop is enabled.
2. Press the **Amp Loop** button again to turn off the Amp Loop. Internal Amp/Cabinets are now again active in the RP1000's effects chain and the external device is bypassed.\*

The Amp Loop can also be assigned to any of the 6-10 numbered footswitches for remote control operation during performance. To assign a footswitch to control the Amp Loop, follow these steps:

1. Press either **Edit** button until the Expression row has been selected (indicated by the Expression row's LED lighting).
2. Rotate **Knob 1** until *F56 ASN - F510 ASN* appears in the Display. This selects which footswitch you are about to change the assignment for.
3. Rotate **Knob 2** until *AMP LOOP* appears in the Display.
4. Store your footswitch assignment to your preset.

**\*Note:** If the **Amp/Cabinet Bypass** button is enabled, internal amp and cabinet effects are bypassed in all presets regardless of whether the Amp Loop is disabled.

Also, if you attempt to enable the Amp Loop without connections being made, the display will briefly read *NO LOOP* indicating there are no connections made to the Amp Loop and the loop will not enable.

### Stomp Loop

The RP1000 also has a stompbox effects loop (Stomp Loop). This loop lets you use an external effects device or effects chain with the RP1000's signal path. The Stomp Loop has a dedicated Stomp Loop footswitch that enables and disables this loop during performance.

The Stomp Loop has the option of being inserted into two different positions in the RP1000's signal path: Pre Amp, or Post Amp. This lets you pick where to place external effects in the loop. The placement of the Stomp Loop can be saved on a per preset basis.

To change the position of the Stomp Loop, follow these steps:

1. Press the **Edit Down** button so that the Expression row is selected.
2. Turn **Knob 1** until *STOMPP05* appears in the Display.
3. Turn **Knob 2** to select one of the two different positions you want to insert the Stomp

Loop: *PRE AMP* (post Distortion, pre Amp Model/Amp Loop send), or *POST AMP* (Post Amp Model/Amp Loop return). Note that the Stomp Loop button's LED turns red when it's pre amp, and green when it's post amp or post FX.

4. Store these changes using the Store procedure.

**Note:** If you try to enable the Stomp Loop but nothing is connected to the Stomp Loop jacks, the Display will briefly read *NO LOOP*. The Stomp Loop will not enable when no connections are present at these jacks.

### Connection Setups

The RP1000 has many different connection options. Here are some more common ways it can be used:

#### Mono Amp

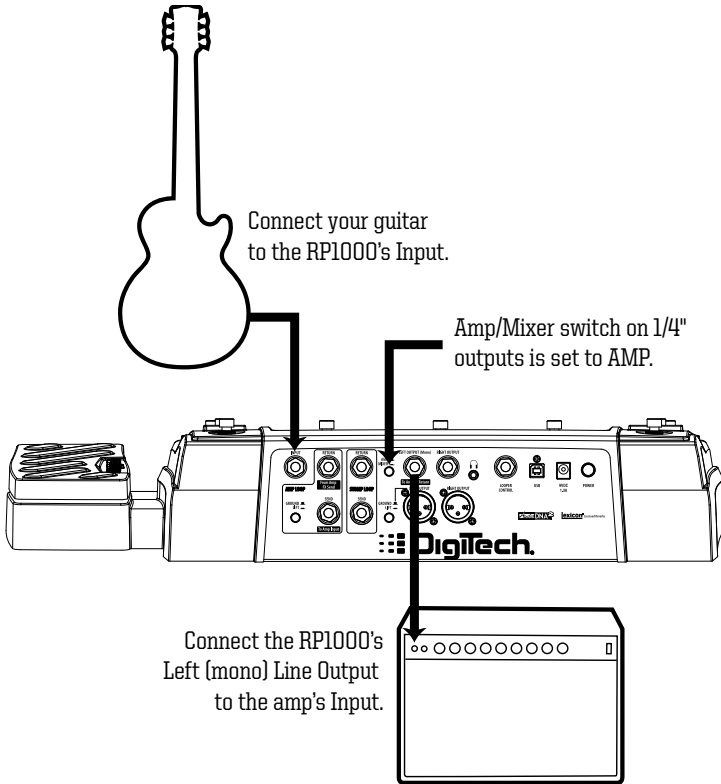

## Mixer

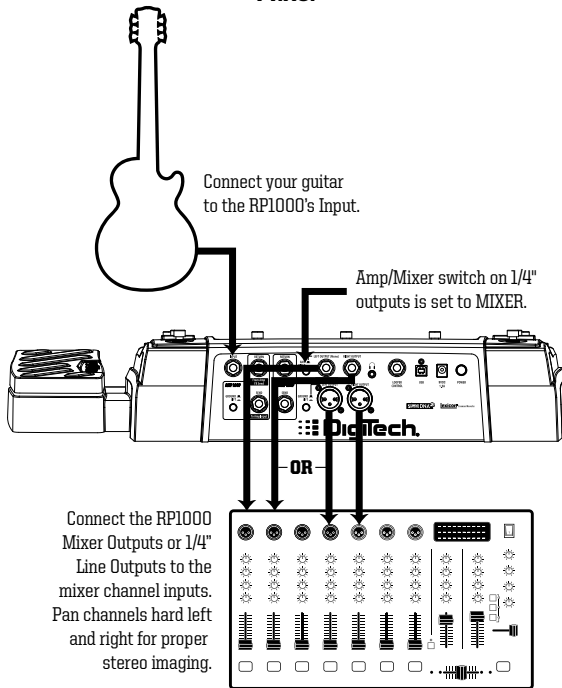

## Stereo Amps

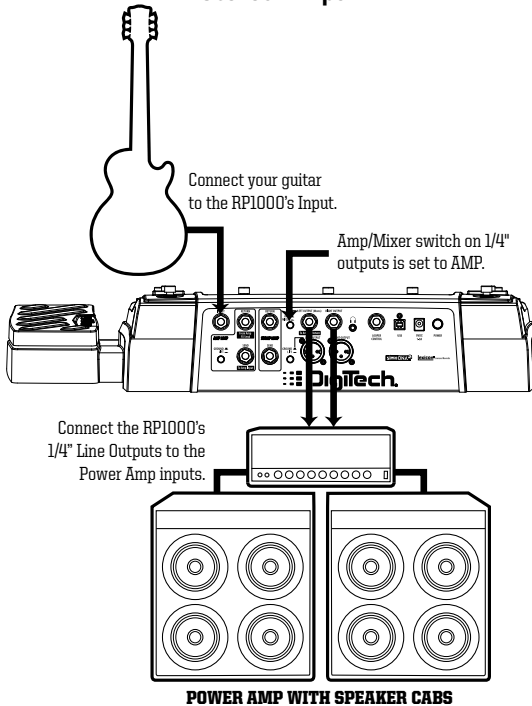

## Amp Loop with Pre-Amp In Line

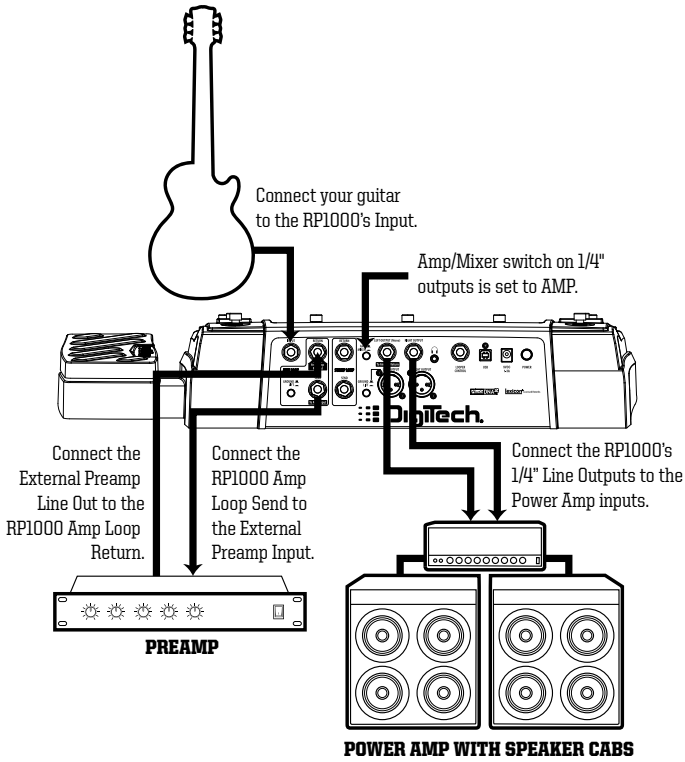

## Stomp Loop

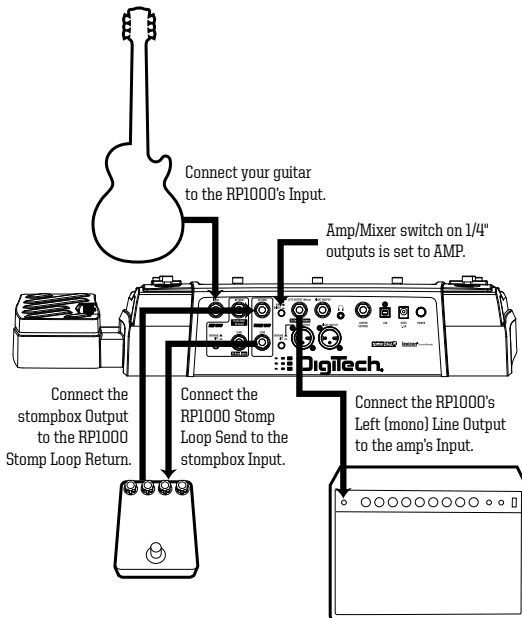

## Amp Loop using Guitar Amp's Pre Amp

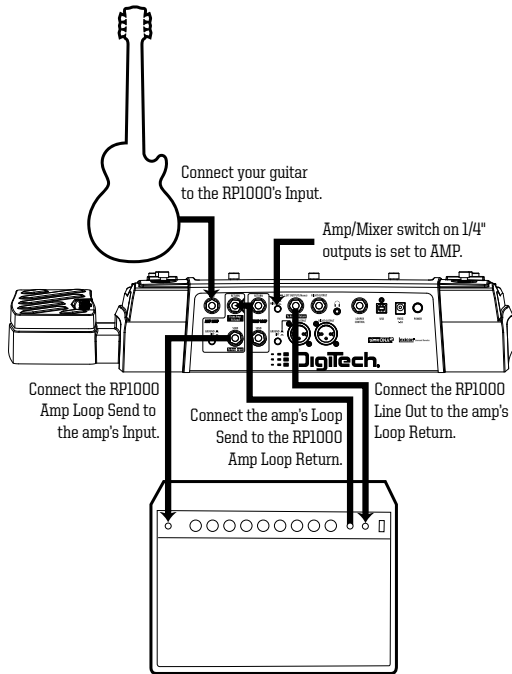

## Amp Loop and Stomp Loop

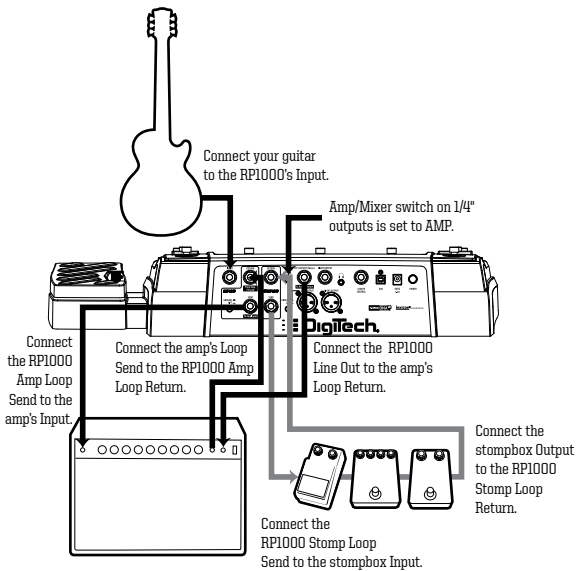



## Studio Setup (Computer and Personal Monitors)

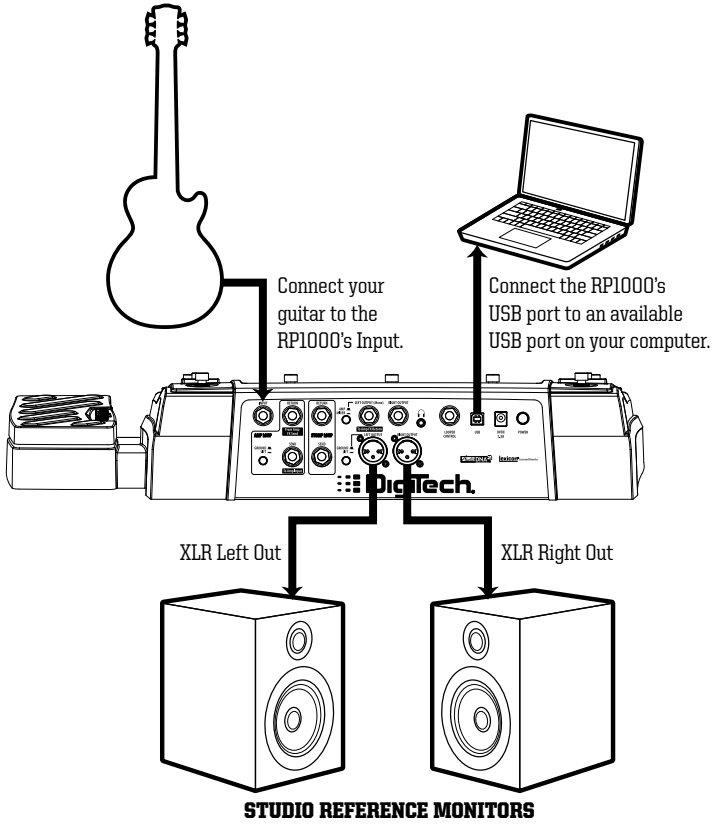

## Applying Power

Before applying power to anything, set your amp(s) to a clean tone and set the tone controls to a flat EQ response (on most amps, this should be set to 5 on EQ's to obtain the amp's natural voicing.). Then follow the steps listed below.

1. Turn your amp volume all the way down.
2. Connect the power supply to the RP1000.
3. Plug the power supply into an AC outlet.
4. Turn on the RP1000's power switch and adjust the RP1000's Master Level to 0.
5. Turn your amp on and adjust the volume to a normal playing level.
6. Gradually increase the RP1000's **Master Level** knob to achieve the desired volume (a setting of 30 will provide approximately a unity gain signal in your system).

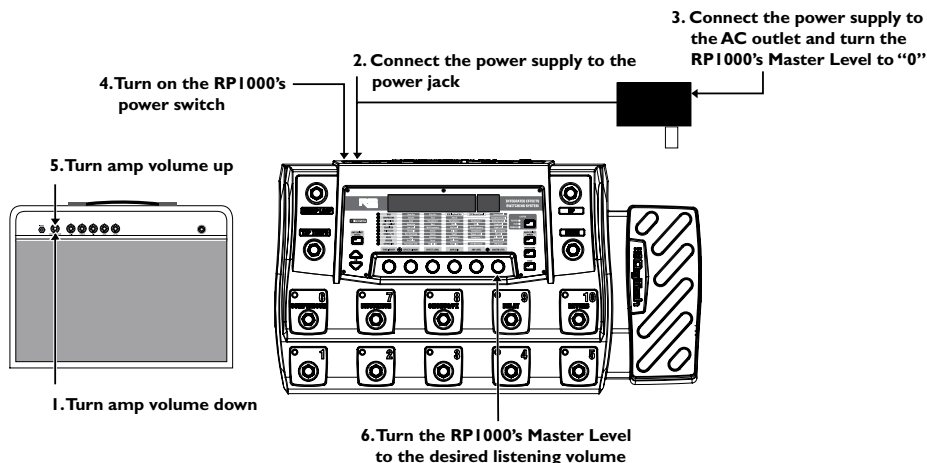

## Section Two - Editing Functions

### Preset Mode and Pedalboard Mode

There are two different ways to use the footswitches with the presets: Preset Mode and Pedalboard Mode. Push the Pedalboard button (just to the right of the knobs below the Display) to toggle between these two modes.

#### Preset Mode

In Preset mode, each of the 10 numbered footswitches loads a preset, and you can't turn individual models on or off with the footswitches. The Up/Down footswitches select banks of 10 presets.

#### Pedalboard Mode

In Pedalboard mode, footswitches 1-5 select presets, and footswitches 6-10 act like pedals on a pedalboard. That means you can turn the distortion, chorus, etc. on and off within each preset. The first time you power up the RP1000 when you take it out of the box (or after doing a factory restore), it's in Pedalboard mode.

The RP1000 remembers which mode you're in when you turn it off, and keeps it in that mode when you turn it back on.

## Editing/Creating Presets

The easiest way to start editing presets is with the **Tone Library** and **Effects Library** knobs. Try out some of the tones in the **Tone Library** and then try out some effects setups with the **Effects Library** knob. Use the **Effects Level Knob** to increase or decrease the overall Chorus/FX, Delay and Reverb levels if desired. Once you find a tone that's pretty close to what you want, use the **Edit** buttons to navigate through the individual effects to make some adjustments. The steps below go into more detail about how this works.

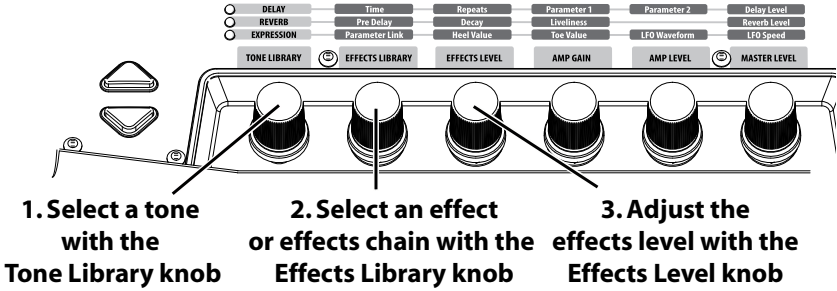

To edit and create a preset:

1. Use the **Up, Down** and numbered Footswitches to select the preset you wish to edit.
2. If you find a preset close to what you want, you can begin editing the effect parameters by pressing the **Edit Up/Down** buttons and selecting the Effect row you want to edit.
3. If you are trying to find something different from the existing presets, begin by using the **Tone Library, Effects Library** and **Effects Level** knobs to get close to a sound you want.
4. Press the **Edit Up/Down** buttons to begin selecting the individual Effects rows to edit their parameters.
5. To bypass or enable an Effect row, press the **Tone Library** knob.
6. Use the **Knobs 2-6** to modify the effect parameter settings.

**Note:** Anytime a stored value within a preset is changed, the **Store** button LED lights up. This indicates that you need to store the changes. Changing presets, or turning the power off before storing any changes, erases any changes made and the RP1000 will revert to the stored values for the preset.

Also, if you are using the RP1000 with the Amp/Cabinet Bypass button enabled (effects only), Tone Libraries that use amps only will not provide distortion or tone changes since amps and cabinets are globally disabled.

## Editing Amp/Cabinet Models

Each RP1000 preset has a ton of world class amp and cabinet models to choose from. To edit amp and cabinet models, follow these steps:

1. Press the **Edit Down** button until the **Amp/Cabinet** row is selected. The row's LED should be lit and the current amp model should be shown in the display.
2. Turn **Knob 1** to select from the different amp models.
3. Press **Knob 1**. The current cabinet model will now be displayed. Turn **Knob 1** to select from the different cabinet models. Pressing **Knob 1** again will return you to the amp model display.
4. To bypass amp/cabinet models in a preset, turn **Knob 1**, fully clockwise until **DIRECT** appears in the RP1000's main display, or enable the **Amp/Cabinet Bypass** button.

## Amp/Cabinet Bypass

The RP1000 has the unique feature of being able to turn off amp and cabinet modeling globally in all presets. This feature is extremely useful when you just want to add effects processing to your own core amplifier sound. The RP1000 basically becomes a straight multi-effects box where only Wah, Compressor, Distortion, Equalizer, Noise Gate, Chorus/FX, Delay, Reverb and any effects connected to the Stomp Loop are the only effects being used.

To bypass amp/cabinet modeling in all presets, press the Amp/Cabinet Bypass button. When it is lit, amp/cabinet modeling is bypassed in all presets.

Amp/Cabinet Bypass can be used in either Preset or Pedalboard mode.

## Storing/Copying/Naming a Preset

When you're done editing a preset, you should store your settings to any of the 100 User preset locations (presets 1-00). The following steps tell you how to store changes to a preset or copy a preset to a different location:

1. Press the **Store** button once. The **Store** button LED blinks and the first character in the Display flashes, indicating that you can now name your custom creation.
2. Use **Knob 1** to select the alpha-numeric character and **Knob 2** to select the next character location.

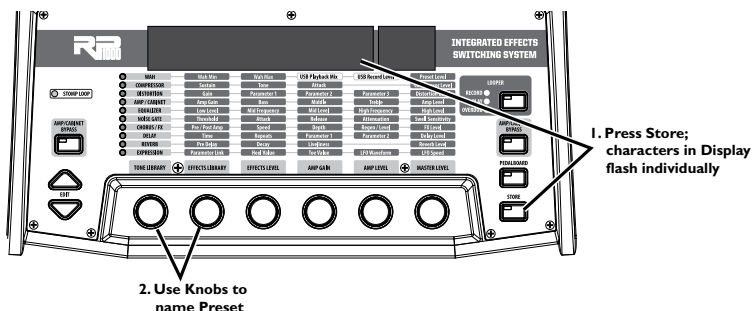

3. Once the desired name is shown in the display, press the **Store** button again to enter the second stage of the storing process. The red Display begins to flash.
4. Select the User preset location where your new sound will reside using the **Up** and **Down Footswitches**. The displays show the preset name and User preset number about to be overwritten.

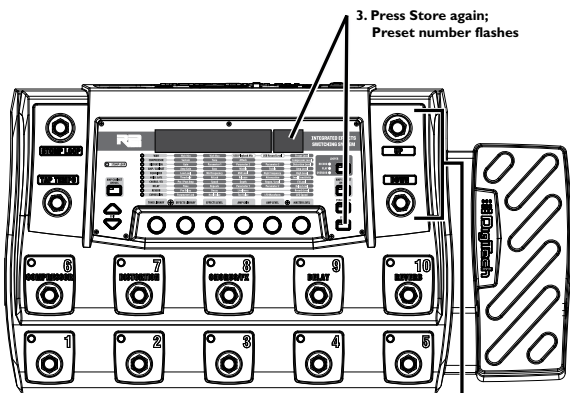

5. Press the **Store** button again to save the changes.

The procedure for copying one preset to another preset location is the same. Use the **Footswitches** to select the preset that you want to copy, then follow steps 1-4 for storing a preset as described above. Press either **Edit** button at any time to abort the Store procedure.

# Section Three - Effects and Parameters

## About the Effects

The RP1000 is like a dream collection of vintage and contemporary amplifiers with several pedalboards full of classic, modern, and boutique stompboxes all in a single programmable, portable package. With stompboxes, the order in which they are connected affects the overall sound. The RP1000 has placed the Amps and Effects in an order for optimum results. The following diagram shows the order in which they are connected.

### Block Diagram

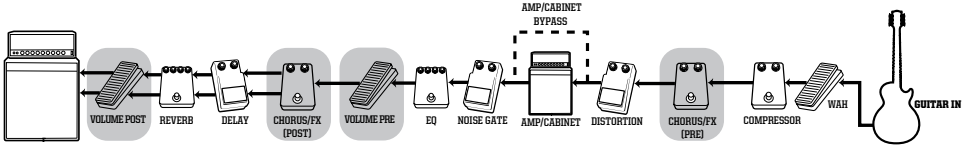

## Effect Definitions

Each Amp and Effect within the RP1000 can be programmed to suit your personal taste and application. Understanding how these components alter the sound, and how each parameter alters the effect, will help you get the sound you are looking for. The following pages talk about the RP1000's amps, cabinets, and effects and what each effect and parameter does. For more information about each effect, like how it's used by some musicians, check out the Effects Descriptions section on page 37.

### Wah

**Wah** is an effect controlled by an Expression Pedal making the guitar sound as if it's saying "Wah."

**Wahs - Knob 1** selects the Wah type. Values include: *CRY WAH* (Cry Wah is a traditional sounding Wah), *CLYDE WAH* based on a Vox® Clyde McCoy™ Wah), and *FULLRANG* (DigiTech® Full Range Wah sweeps the entire spectrum of audible frequencies). Press this knob to turn Wah on and off.

**Wah Level - Knob 2** adjusts the Wah Level. Ranges from 0dB to +12dB.

### Compressor

A **Compressor** is used to increase sustain, tighten up guitars, and prevent the signal from clipping the input of other effects. It sets a maximum boundary for the strength of a signal.

**Comp - Knob 1** selects one of three Compressors: *DIGICOMP* (DigiTech® Compressor), *CS COMP* (Based on a Boss® CS-2 Compressor/Sustainer), or *DYNOCOMP* (Based on an MXR® Dynacomp). Press this knob to turn the selected Compressor on and off.

**Knobs 2-6** have the following functions for the various Compressors:

Compressor	Knob 2 (Sustain)	Knob 3 (Tone)	Knob 4 (Attack)	Knob 5	Knob 6 (Compressor Level)
<i>DIGICOMP</i>	Sustain	Tone	Attack	--	Level
<i>CS COMP</i>	Sustain	--	Attack	--	Level
<i>DYNOCOMP</i>	Sensitivity	--	--	--	Output

## Distortion

The RP1000 includes the tones of many popular distortion stompboxes, each of which can be fully dialed in.

**Distortion - Knob 1** selects a Distortion. Press this knob to turn the selected Distortion on and off.

<b>SCREAMER</b> - Based on an Ibanez® TS-9	<b>OCD DRIVE</b> - Fulltone OCD Overdrive
<b>808</b> - Based on an Ibanez TS-808 Tube Screamer	<b>RODENT</b> - Based on a Pro Co RAT™
<b>TS MOD</b> - Based on a modified Ibanez® TS-9	<b>MX DIST</b> - Based on an MXR® Distortion +
<b>SD DRV</b> - Based on a Boss SD-1™ Overdrive	<b>DS DIST</b> - Based on a Boss® DS-1™ Distortion
<b>OD DRV</b> - Based on a Boss OD-1™ Overdrive	<b>GRUNGE</b> - DigiTech® Grunge®
<b>SPARK DRV</b> - Based on a Voodoo Labs Sparkle Drive	<b>ZONE</b> - Based on a Boss MT-2 Metal Zone®
<b>GUY DRV</b> - Based on a Guyatone® Overdrive OD-2	<b>DEATH</b> - DigiTech Death Metal™
<b>DOD 250</b> - Based on a DOD® 250 Overdrive/Preamp	<b>GONKULTR</b> - Based on a DOD Gonkulator
<b>REDLINE</b> - DigiTech® Redline Overdrive	<b>BTAVIA</b> - Based on a Roger Mayer Octavia™
<b>AMPDRIVER</b> - DigiTech Amp Driver	<b>FUZZLATOR</b> - Based on a Demeter Fuzzulator
	<b>CLASSFUZ</b> - Based on a DOD Classic Fuzz
	<b>FUZZYFACE</b> - Based on an Arbiter® Fuzz Face™
	<b>BIG PI</b> - Based on an Electro-Harmonix® Big Muff Pi®

**Knobs 2-6** have the following functions for the various Distortions:

<b>Distortion</b>	<b>Knob 2 (Gain)</b>	<b>Knob 3 (Param. 1)</b>	<b>Knob 4 (Param. 2)</b>	<b>Knob 5 (Param. 3)</b>	<b>Knob 6 (Distortion Level)</b>	<b>P7 (X-Edit™ only)</b>
SCREAMER	Drive	Tone	--	--	Level	--
BOB	Overdrive	Tone	--	--	Level	--
TS MOD	Drive	Tone	--	--	Level	--
SD ODRV	Drive	Tone	--	--	Level	--
OD ODRV	Overdrive	Tone	--	--	Level	--
SPARK DRV	Gain	Tone	Clean	--	Volume	--
GUY ODRV	Drive	--	--	--	Level	--
DD 250	Gain	--	--	--	Level	--
REDLINE	Gain	Low	High	--	Level	--
AMPDRIVER	Gain	Mid Boost	--	--	Level	--
DC DRIVE	Drive	Tone	HP/LP	--	Volume	--
RODENT	Distortion	Filter	--	--	Level	--
MX DIST	Distortion	--	--	--	Output	--
DS DIST	Gain	Tone	--	--	Level	--
GRUNGE	Grunge	Butt	Face	--	Loud	--
ZONE	Gain	Low	Mid	High	Level	Mid Freq
DEATH	--	Low	Mid	High	Level	--
GONKULTR	Gunk	Smear	Suck	--	Heave	--
BATAKIA	Drive	--	--	--	Volume	--
FUZZLATR	Fuzz	Tone	Loose/Tight	--	Volume	--
CLASCFUZ	Fuzz	Tone	--	--	Volume	--
FUZZYFAC	Fuzz	--	--	--	Volume	--
BIG PI	Sustain	Tone	--	--	Volume	--

## Amplifier

The amplifiers are an assortment of popular vintage and modern amp tones. The amplifiers also include acoustic guitar simulations.

**Amp** - By default, **Knob 1** selects one of the classic, modern, and DigiTech custom Amp types. Note that when you select an Amp, the default cabinet is automatically selected. You can, however, change the cabinet after selecting an Amp to achieve different tones. Press this knob and turn it to select a cabinet. Press this knob again to return to the Amp types and parameters.

57 CHAMP	Based on a '57 Fender® Tweed Champ®	CHIEF	Based on a '95 Matchless Chieftan
57DELUXE	Based on a '57 Fender Tweed Deluxe	SLDND100	Based on an '88 Soldano SLO-100
59BASSMN	Based on a '59 Fender Tweed Bassman®	SUPERGRP	Based on a Laney Supergroup.
62BASSMN	Based on a '62 Fender Brown Bassman	GA-40	Based on a Gibson® GA-40
65 TWIN	Based on a '65 Fender Blackface Twin Reverb®	OR-120	Based on an Orange OJ120.
65DELUXRV	Based on a '65 Fender Blackface Deluxe Reverb®	PV 5150	Based on a Peavey® 5150 II®
45 JTM	Based on a '65 Marshall® JTM-45	RG100	Based on a Randall RG100
68 PLEXI	Based on a '68 Marshall 100 Watt Super Lead (plexi)	JAZZ 120	Based on a Roland JC120
JUMPPANL	Based on a '68 Marshall Jump Panel	SOLAR100S	Based on a Sunn Solar 100S
MASTRVOL	Based on a '77 Marshall Master Volume	DIG SOLO	80s shred guitar.
800 JCM	Based on an '83 Marshall JCM800	DIGMETAL	Heavy.
900 JCM	Based on a '93 Marshall JCM900	DIGBRIGHT	Sparkle clean.
2000 JCM	Based on an '01 Marshall JCM2000	DIGCHUNK	Beefy high gain with tight bottom end.
AC15	Based on a '62 Vox® AC15	DIGCLEAN	Sparkle clean.
AC30 TB	Based on a '63 Vox AC30 Top Boost	DIG GAIN	Punchy high gain that cleans up.
HIWATTAG	Based on a '69 Hiwatt® Custom 100 DR103	DIGBLUES	Tube combo at the sweet spot.
MARK IIC	Based on an '81 Mesa Boogie® Mark II C	DIG FUZZ	Fuzz Face + Orange Amp
MARK IV	Based on a '94 Mesa Boogie® Mark IV	DIGSPANK	Cool rhythm tone with spanky top end.
DUALRECT	Based on an '01 Mesa Boogie Dual Rectifier	2101 CLN	DigiTech 2101 Clean Tube
TRIPRECT	Based on an '04 Mesa Boogie Triple Rectifier	2101 SAT	DigiTech 2101 Saturated Tube
22 CALIBR	Based on an '86 Mesa Boogie .22 Caliber	DIGCRUNCH	Based on a modified Plexi.
99 LEGACY	Based on a 99 Legacy VL-100	DIGNSTR	Maxed out gain.
MATCHC30	Based on a '96 Matchless™ HC30	DIGTWEED	Based on a Tweed front Blackface power hybrid.
		DIGBLACK	Based on a '65 Blackface into a '58 Bassman.
		DIGSTONR	DigiTech stoner rock.
		DIGDKMTL	DigiTech dark metal.
		DIGTRANS	Based on a transistor amp - "Deacy" from Brian May.
		DIGBROWN	Brown sound.
		DIG MOSH	DigiTech mosh.
		DREAD AC	Dreadnaught acoustic
		JUMBO AC	Jumbo acoustic
		DIRECT	No amp





**Cabinet - Knob 1** also selects cabinets. Pressing this knob alternates between selecting amps and cabinets

CHAMP1X8 - Based on a 1x8 '57 Fender® Tweed Champ®	GRN4X12 - Based on a 4x12 Marshall 1969 Slant w/ Celestion 25W Greenbacks
DLUX1X12 - Based on a 1x12 '57 Fender Tweed Deluxe®	FANE4X12 - Based on a 4x12 Hiwatt® Custom w/ Fane Speakers
DXRV1X12 - Based on a 1x12 '65 Fender Blackface Deluxe Reverb	BOTG4X12 - Based on a 4x12 '96 VHT® Slant w/ Celestion Vintage 30's
BRIT1X12 - Based on a 1x12 '62 Vox® AC15 w/20W Vox Speaker	VNTG4X12 - Based on a 4x12 Johnson® Straight w/ Celestion Vintage 30's
GBSN1X12 - Based on a '60 Gibson® GA-40 Jensen Speaker	RECT4X12 - Based on a 4x12 Mesa/Boogie Rectifier V30 speakers
BMAN2X12 - Based on a 2x12 '57 Fender Blonde Bassman®	SOLO4X12 - 4x12 DigiTech® Solo
TWIN2X12 - Based on a 2x12 '65 Fender Blackface Twin Reverb®	BRGT2X12 - 2x12 DigiTech Bright
BRIT2X12 - Based on a 2x12 '63 Vox® AC30 Top Boost w/ Jensen® Blue Backs	METL4X12 - 4x12 DigiTech Metal
JAZZ2X12 - Based on a 2x12 '84 Roland® Jazz Chorus	ROCK4X12 - 4x12 DigiTech Rock
JBL 2X15 - Based on a JBL/Lansing Enclosure	ALT4X12 - 4x12 DigiTech Alt Rock
BMAN4X10 - Based on a 4x10 '59 Fender Tweed Bassman®	VYTG4X12 - 4x12 DigiTech Vintage
CLAS4X12 - Based on a 4x12 Marshall® 1969 Straight w/ Celestion® G12-T70	CHNK4X12 - 4x12 DigiTech Chunk
	SPNK4X12 - 4x12 DigiTech Spank
	DIGISPKR - DigiTech Speaker Compensation
	DIRECT - No cabinet

**Amp Gain - Knob 2** adjusts the Gain (distortion) for the selected Amp (not available for Acoustic). The Gain parameter ranges from 0 to 99.

**Bass - Knob 3** adjusts the low frequencies of the amp's tone. Ranges from 1.0 to 10.

**Middle - Knob 4** adjusts the mid frequencies of the amp's tone. Ranges from 1.0 to 10.

**Treble - Knob 5** adjusts the high frequencies of the amp's tone. Ranges from 1.0 to 10.

**Amp Level - Knob 6** adjusts the Level (volume) of the selected Amp. The Level parameter ranges from 0 to 99.

## EQ

The RP1000's EQ helps further shape your tone with Low, Mid, and High controls.

**Knob 1** - Press **Knob 1** to turn the EQ on and off.

**Low Level** - Knob 2 adjusts the Low EQ level. Ranges from -12dB to 12dB.

**Mid Frequency** - **Knob 3** selects the frequency that the Mid parameter adjusts. Range is from 300 Hz to 4000 Hz.

**Mid Level** - Knob 4 adjusts the Mid EQ level. Range is from -12dB to 12dB.

**High Frequency** - **Knob 5** adjusts the High EQ frequency. Range is from 2000 Hz to 8000 Hz

**High Level** - **Knob 6** adjusts the High EQ level. Range is from -12dB to 12dB.

**Low Frequency (X-Edit™ only)** - This parameter selects the Low EQ frequency. Ranges from 60 Hz to 500 Hz.

**Low, Mid, and High Bandwidth (X-Edit only)** - This parameter selects the frequency bandwidth for each frequency band. Range is from Narrow to Wide.

## Noise Gate/Auto Swell

A **Noise Gate** is designed to eliminate noise while you are not playing, or provide an auto volume swell effect.

**Gate Type** - **Knob 1** selects between the DigiTech® noise gate or the volume swell effect. Values include: *GATE* (Selects the Noise Gate) and *SWELL* (Selects the Auto Swell effect.) Press this knob to turn the Noise Gate/Auto Swell on and off.

**Threshold (Noise Gate only)** - **Knob 2** sets the signal strength (Threshold) required to open or close the Noise Gate. Parameters range from 0 (opens easily) to 99 (requiring strong signals to open).

**Attack Time** - **Knob 3** sets the attack time. Ranges from 0 (shorter attack time) to 99 (longer attack time).

**Release** - **Knob 4** sets the Release parameter. Ranges from 0 to 99.

**Attenuation** - **Knob 5** sets the Attenuation parameter. Ranges from 0 to 99.

**Swell Sensitivity (Auto Swell only)** - **Knob 6** sets the Swell Sensitivity parameter of the Auto Swell. Ranges from 0 to 99.

## Chorus/FX

The Chorus/FX row in the RP1000 is a multi-function module, allowing you to select Effect types such as Chorus, Flanger, Phaser, Vibrato, Rotary Speaker, Tremolo, Panner, Envelope Filter, Detune, Whammy™, Pitch Shift, Detune, Harmony, OC Octaver and more. When the Chorus/FX row is selected, **Knob 1** is used to choose the Effect type. Press this knob to turn these Effects on and off. Only one of the effects in this row can be used at a time. After selecting the type of effect in this module, **Knobs 2-6** can then be used to adjust the individual parameters associated with the selected effect. The following list describes each Effect and its parameters in more detail:

### Chorus

A Chorus adds a short delay to your signal. The delayed signal is modulated in and out of tune and then mixed back with the original signal to create a thicker sound. The RP1000 includes the following Chorus Effects: *EECHORUS* (based on the classic Boss® CE-2 Chorus), *TECHORUS* (based on the TC Electronic Chorus), *CHORUS* (DigiTech®'s Dual Chorus), *GLISCHUS* (DigiTech's Glistening Chorus) and *MULTCHRS* (DigiTech's famous Multi Chorus®), *VOO DOO* (based on the VooDoo Labs Analog Chorus), and *CLONE* (Based on the Electro Harmonix Small Clone).

**Knobs 2-6** have the following functions for the various Chorus types:

Chorus	Knob 2 (Pre/Post Amp)	Knob 3 (Speed)	Knob 4 (Depth)	Knob 5 (Regenera- tion)	Knob 6 (FX Level)
<i>CECHORUS</i>	Pre/Post Amp	Speed	Depth	--	--
<i>TECHORUS</i>	Pre/Post Amp	Speed	Width	--	Intensity
<i>CHORUS</i>	Pre/Post Amp	Speed	Depth	Waveform	Level
<i>GLISCHRS</i>	Pre/Post Amp	Speed	Depth	--	Level
<i>MULTCHRS</i>	Pre/Post Amp	Speed	Depth	Waveform	Level
<i>VOO DOO</i>	Pre/Post Amp	Speed	Intensity	--	--
<i>CLONE</i>	Pre/Post Amp	Rate	Depth	--	--

## Flanger

A Flanger uses the same principle as a Chorus but uses a shorter delay time and adds regeneration (or repeats) to the modulating delay. This results in an exaggerated up and down sweeping motion to the effect. The RPI000 includes the following Flanger Effects: *FLANGER* (the DigiTech® Flanger), *TRIGFLNG* (the DigiTech Triggered Flanger), *FLTRFLNG* (the DigiTech Filter Flanger), *MX FLNGR* (based on an MXR® Flanger), *EH FLNGR* (based on an Electro-Harmonix® Electric Mistress), and *AD FLNGR* (based on an A/DA Flanger).

**Knobs 2-6** have the following functions for the various Flanger types:

Flanger	Knob 2 (Pre/Post Amp)	Knob 3 (Speed)	Knob 4 (Depth)	Knob 5 (Regenera- tion)	Knob 6 (FX Level)
<i>FLANGER</i>	Pre/Post Amp	Speed	Depth	Regen	Level
<i>TRIGFLNG</i>	Pre/Post Amp	Speed	Sensitivity	LFO Start	Level
<i>FLTRFLNG</i>	Pre/Post Amp	Speed	Depth	Regen	Frequency
<i>MX FLNGR</i>	Pre/Post Amp	Speed	Width	Regen	Manual
<i>EH FLNGR</i>	Pre/Post Amp	Rate	Range	Color	--
<i>AD FLNGR</i>	Pre/Post Amp	Speed	Enhance	Range	Manual

## Phaser

A phaser splits the incoming signal, and then changes the phasing of the signal. This signal is then taken in and out of phase and mixed back in with the original signal. As the phasing changes, different frequencies get canceled resulting in a warm sort of twisting sound. The RP1000 includes the following Phaser types: *PHASER* (the DigiTech Phaser), *TRIGPHAS* (the DigiTech Triggered Phaser), *MX PHASR* (based on an MXR Phase 100), and *EH PHASR* (based on an Electro-Harmonix Small Stone).

**Knobs 2-6** have the following functions for the various Phaser Effects:

Phaser	Knob 2 (Pre/Post Amp)	Knob 3 (Speed)	Knob 4 (Depth)	Knob 5 (Regenera- tion)	Knob 6 (FX Level)
<i>PHASER</i>	Pre/Post Amp	Speed	Depth	Regen	Level
<i>TRIGPHAS</i>	Pre/Post Amp	Speed	Sensitivity	LFO Start	Level
<i>MX PHASR</i>	Pre/Post Amp	Speed	Intensity	--	--
<i>EH PHASR</i>	Pre/Post Amp	Rate	--	Color	--

## Vibrato (*VIBRATO*)

The DigiTech Vibrato effect modulates the pitch of the incoming signal at an even rate.

**Pre/Post Amp - Knob 2** determines where the effect appears in the effects chain. Turn counter-clockwise for Pre (appears before the Distortion effect), or clockwise for Post (appears after the Noise Gate effect).

**Speed - Knob 3** adjusts the rate (Speed) at which the pitch modulates. Ranges from 0 to 99.

**Depth - Knob 4** adjusts the intensity (Depth) of the modulating pitch. Ranges from 0 to 99.

## Rotary Speaker (*ROTARY*)

The Rotary Speaker emulates a device that included a spinning horn and woofer. The rotation of these two speakers produced an interesting combination of the sound panning from side to side. This produced a slight pitch change due to the speed of the sound coming towards, and then going away from the listener.

**Pre/Post Amp - Knob 2** determines where the effect appears in the effects chain. Turn counter-clockwise for Pre (appears before the Distortion effect), or clockwise for Post (appears after the Noise Gate effect).

**Speed - Knob 3** adjusts the rate (Speed) of the spinning speakers. Ranges from 0 to 99.

**Intensity - Knob 4** controls the intensity of the effect. Ranges from 0 to 99.

**Doppler - Knob 5** controls the Pitch Shift effect that is the ratio between the horn and the rotor positions. Ranges from 0 to 99.

**Crossover - Knob 6** selects the crossover frequency between the horn and rotor. Ranges from 0 (200 Hz) to 99 (1600 Hz).

## **VibroPan** (*VIBROPAN*)

A vibrato is an effect that modulates the pitch of the incoming signal. This will take the whole signal slightly in and out of tune at a steady pace. The DigiTech® VibroPan also incorporates an automatic panner with the vibrato effect that creates a lush chorus-like sound.

**Pre/Post Amp - Knob 2** determines where the effect appears in the effects chain. Turn counter-clockwise for Pre (appears before the Distortion effect), or clockwise for Post (appears after the Noise Gate effect).

**Speed - Knob 3** adjusts how fast the signal is being modulated.

**Depth - Knob 4** adjusts the amount of pitch change.

**Vibrato/Pan- Knob 5** adjusts the amount of panning incorporated with the vibrato effect. When set at 0, this effect is a standard vibrato. As the parameter is turned up, the phase difference of the vibrato signal sent to the two channels is changed until a full stereo image is obtained at 99.

**Waveform - Knob 6** selects a waveform: *TRIANGLE*, *SINE*, or *SQUARE*.

## **Unicord Uni-Vibe™** (*UNOVIBE*)

Based on the Unicord® Uni-Vibe™ pedal, Uni-Vibe adds a lush chorus or rotary speaker (vibrato) effect to your tone.

**Pre/Post Amp - Knob 2** determines where the effect appears in the effects chain. Turn counter-clockwise for Pre (appears before the Distortion effect), or clockwise for Post (appears after the Noise Gate effect).

**Speed - Knob 3** adjusts the rate (Speed) of the chorus modulation or spinning speaker (vibrato) effect. Ranges from 0 to 99.

**Intensity - Knob 4** controls the intensity of the effect. Ranges from 0 to 99.

**Chorus/Vibrato - Knob 5** selects either the chorus or vibrato effect. Turn counter-clockwise for Chorus, or clockwise for Vibrato.

**Volume - Knob 6** adjusts the volume of the effect.

## **Tremolo/Panner**

A Tremolo effect modulates the volume of the signal at an even rate. The RP1000 includes the following Tremolo types: *TREMLO* (the DigiTech® Tremolo), *SCTRTREM* (DigiTech Scattertrem (dual asynchronous tremolos)), *OPTOTREM* (based on the Fender® Opto Tremolo), *BIASTREM* (based on the Vox® Bias Tremolo), and *PANNER* (the DigiTech Panner).

**Pre/Post Amp - Knob 2** determines where the effect appears in the effects chain. Turn counter-clockwise for Pre (appears before the Distortion effect), or clockwise for Post (appears after the Noise Gate effect).

**Speed - Knob 3** adjusts the rate (Speed) at which the volume modulates. Ranges from 0 to 99.

**Depth - Knob 4** adjusts the intensity (Depth) of the modulating volume. Ranges from 0 to 99.

**Waveform (DigiTech Tremolo and Panner only) - Knob 5** selects a waveform: *TRIANGLE*, *SINE*, or *SQUARE*.

### Envelope Filter (ENVFILTR)

The DigiTech Envelope Filter is a dynamic Wah effect that alters your sound based upon how hard you play.

**Pre/Post Amp - Knob 2** determines where the effect appears in the effects chain. Turn counter-clockwise for Pre (appears before the Distortion effect), or clockwise for Post (appears after the Noise Gate effect).

**Sensitivity - Knob 3** adjusts the sensitivity or the input signal required to trigger the Wah effect. Ranges from 0 to 99.

**Range - Knob 4** controls the range of the Envelope effect. Ranges from 0 to 99.

### DOD FX25 (FX25 ENV)

This envelope filter is based on the DOD FX25.

**Pre/Post Amp - Knob 2** determines where the effect appears in the effects chain. Turn counter-clockwise for Pre (appears before the Distortion effect), or clockwise for Post (appears after the Noise Gate effect).

**Blend - Knob 3** adjusts the balance between effect signal and dry signal.

**Sensitivity - Knob 4** adjusts the sensitivity or the input signal required to trigger the Wah effect. Ranges from 0 to 99.

**Range - Knob 5** controls the range of the envelope effect. Ranges from 0 to 99.

### AutoYa™ (AUTO YA)

An AutoYa™ combines the characteristics of a Wah and a Flanger together creating an almost human vowel characteristic as if the guitar were saying “Yah.” The AutoYa automatically provides this animation to the sound at an even rate.

**Pre/Post Amp - Knob 2** determines where the effect appears in the effects chain. Turn counter-clockwise for Pre (appears before the Distortion effect), or clockwise for Post (appears after the Noise Gate effect).

**Speed - Knob 3** adjusts the speed of the AutoYa sweep. Ranges from 0 to 99.

**Intensity - Knob 4** adjusts the intensity of the AutoYa effect. Ranges from 0 to 99.

**Range - Knob 5** adjusts the throaty quality of the AutoYa effect. Ranges from 0 to 49.

### YaYa™ (YA YA)

The YaYa™ is another effect exclusive to DigiTech products. Like the AutoYa, it combines the characteristics of a wah and a flanger together providing a unique talk box type of effect, but is controlled by the Expression Pedal.

**Pre/Post Amp - Knob 2** determines where the effect appears in the effects chain. Turn counter-clockwise for Pre (appears before the Distortion effect), or clockwise for Post (appears after the Noise Gate effect).

**Pedal - Knob 3** adjusts the Ya pedal position. Ranges from 0 to 99.

**Intensity - Knob 4** adjusts the intensity of the YaYa effect. Ranges from 0 to 99.

**Range - Knob 5** adjusts the throaty quality of the YaYa effect. Ranges from 0 to 49.

### SynthTalk™ (SYNTHTLK)

SynthTalk™ is another effect exclusive to DigiTech®. It makes your guitar appear to speak based upon the dynamics of your playing style.

**Pre/Post Amp - Knob 2** determines where the effect appears in the effects chain. Turn counter-clockwise for Pre (appears before the Distortion effect), or clockwise for Post (appears after the Noise Gate effect).

**Release - Knob 4** adjusts the release of the synthesized voice. Ranges 0 to 99, and 00 (infinity).

**Vox - Knob 5** changes the characteristics of the various synth voices. Ranges from 0 to 99.

**Sensitivity - Knob 6** adjusts the sensitivity of the input signal required to trigger the SynthTalk effect. Ranges from 0 to 99.

**Balance (X-Edit™ only)** - adjusts the left to right balance of the wet signal, Ranges from LEFT 99 to RIGHT 99.

### Step Filter (STEPFLTR)

The DigiTech Step Filter is like an automatic “random wah” with a square waveform.

**Pre/Post Amp - Knob 2** determines where the effect appears in the effects chain. Turn counter-clockwise for Pre (appears before the Distortion effect), or clockwise for Post (appears after the Noise Gate effect).

**Speed - Knob 3** adjusts the speed of the Wah effect. Ranges from 0 to 99.

**Intensity - Knob 4** controls the intensity of the Wah effect. Ranges from 0 to 99.

### Sample Hold (SMPHOLD)

The DigiTech Sample Hold randomly shifts the pitch of the note you’re playing, creating an “electronic” or “robotic” sound.

**Pre/Post Amp - Knob 2** determines where the effect appears in the effects chain. Turn counter-clockwise for Pre (appears before the Distortion effect), or clockwise for Post (appears after the Noise Gate effect).

**Speed - Knob 3** adjusts the speed of the Sample Hold effect. Ranges from 0 to 99.

**Intensity - Knob 4** controls the intensity of the Sample Hold effect. Ranges from 0 to 99.

### DigiTech Whammy® (WHAMMY)

The DigiTech Whammy® is an effect that uses an Expression Pedal to bend the pitch of the incoming signal, or add a bendable harmony with the original signal. As the Pedal is moved, the note bends either up or down. When DigiTech Whammy is selected, it is automatically placed before the internal amplifiers as shown in the block diagram on page 17.

**Pre/Post Amp - Knob 2** determines where the effect appears in the effects chain. Turn counter-clockwise for Pre (appears before the Distortion effect), or clockwise for Post (appears after the Noise Gate effect).

**Shift Amount - Knob 3** selects the interval and direction of the pitch bend. Choices are as follows:

#### Whammy™ (no Dry Signal)

1 OCT UP (1 octave above)  
 2 OCT UP (2 octaves above)  
 2ND DOWN (a second below)  
 REV 2ND (a second below reversed pedal action)  
 4TH DOWN (a fourth below)  
 1 OCT DN (an octave below)  
 2 OCT DN (2 octaves below)  
 DIVE BOMB (Dive Bomb)

#### Harmony Bends (Dry Signal Added)

MN3; MAJ3 (a minor third to a Major third)  
 2ND; MAJ3 (a second above to a Major third above)  
 3RD; 4TH (a third above to a fourth above)  
 4TH; 5TH (a fourth above to a fifth above)  
 5TH OCT UP (a fifth above to an octave above)  
 H OCT UP (one octave above)  
 H OCT DN (one octave down)  
 OCT UP; DN (octave up/down)

**Pedal Position - Knob 5** provides a manual control of the Whammy pedal position. Ranges from 0 to 99.

**Mix - Knob 6** adjusts the Whammy mix. Ranges from 0 to 99.

### Pitch Shift (*PITCH*)

A Pitch Shifter copies the incoming signal, then shifts the pitch of the copy to a different note. The shifted note is then mixed back with the original signal, sounding as if two guitars were playing different notes.

**Pre/Post Amp - Knob 2** determines where the effect appears in the effects chain. Turn counter-clockwise for Pre (appears before the Distortion effect), or clockwise for Post (appears after the Noise Gate effect).

**Shift Amount - Knob 3** selects the interval of the shifted pitch. Ranges from  $-2^4$  (2 octaves below) to  $2^4$  (2 octaves above).

**Mix - Knob 6** controls the mix level of the shifted pitch. Ranges from 0 to 99.

### Detune (*DETUNE*)

A Detuner makes a copy of your incoming signal, takes the copied signal slightly out of tune from the original, then mixes the two signals together. The result is a doubling type of effect as if two guitars were playing the same part together.

**Pre/Post Amp - Knob 2** determines where the effect appears in the effects chain. Turn counter-clockwise for Pre (appears before the Distortion effect), or clockwise for Post (appears after the Noise Gate effect).

**Shift Amount - Knob 3** adjusts the amount of detune shift. Ranges from  $-2^4$  to  $2^4$  cents.

**Level - Knob 6** controls the mix of the detuned note. Ranges from 0 to 99.

### Harmony Pitch Shifting (*HARMONY*)

Harmony Pitch Shifting makes a copy of the incoming signal, and then changes the pitch of the copied note to a diatonically correct interval specified by the Amount parameter. A Harmony Pitch Shifter sharpens or flattens the shifted pitch in order to keep the specified interval within the selected key and scale creating a true harmony.

**Pre/Post Amp - Knob 2** determines where the effect appears in the effects chain. Turn counter-clockwise for Pre (appears before the Distortion effect), or clockwise for Post (appears after the Noise Gate effect).

**Shift Amount - Knob 3** selects the *amount* or *harmony interval* for the Harmony Pitch Shifter. Interval choices include:

0CT DN (octave down)	2ND UP (a second above)
7TH DN (a seventh below)	3RD UP (a third above)
6TH DN (a sixth below)	4TH UP (a fourth above)
5TH DN (a fifth below)	5TH UP (a fifth above)
4TH DN (a fourth below)	6TH UP (a sixth above)
3RD DN (a third below)	7TH UP (a seventh above)
2ND DN (a second below)	0CT UP (an octave above)

**Key - Knob 4** selects the musical key that the HPS uses. Key choices range from the Key of E (*KEY E*) through the Key of E<sub>b</sub> (*KEY Eb*).

**Scale - Knob 5** selects the scale the HPS will use. Scale choices include: Major (*MAJOR*), Minor (*MINOR*), Dorian (*DORIAN*), Mixolydian (*MIXOLYDN*), Lydian (*LYDIAN*), and Harmonic Minor (*HARMMINR*).

**Level - Knob 6** adjusts the HPS Level of all the pitch-altering effects in this module. Ranges from 0 to 99.



## Boss® OC-2 Octaver™ (OCTAVER)

Based on the Boss® OC-2 Octaver™, this adds two signals to your original guitar signal. The first is one octave below your guitar, and the second is two octaves below your guitar. Each additional signal has its own volume control.

**Pre/Post Amp - Knob 2** determines where the effect appears in the effects chain. Turn counter-clockwise for Pre (appears before the Distortion effect), or clockwise for Post (appears after the Noise Gate effect).

**Octave 1 - Knob 3** adjusts the the volume of the signal 1 octave below the input signal. Ranges from 0 to 99.

**Octave 2 - Knob 4** controls the volume of the signal 2 octaves below the input signal. Ranges 0 to 99.

**Dry Level - Knob 6** controls the volume of the dry signal. Ranges from 0 to 99.

## Delay

Delay is an effect that records a portion of the incoming signal, and then plays it back a short time later. The recording can repeat just once or several times.

**Delay - Knob 1** selects one of the 7 different Delay types. Values include: *ANALOG* (DigiTech® Analog Delay), *DM DELAY* (Based on the Boss DM-2 Analog Delay), *DIGITAL* (DigiTech Digital Delay), *MODULATE* (DigiTech Modulated Delay), *PINGPONG* (DigiTech Pong Delay), *TAPE* (DigiTech Tape Delay), *ECHOPLEX* (Based on the Maestro™ EP-2 Echoplex® Tape Echo), *REVERSE* (DigiTech Reverse Delay), *LO FI* (a Lo Fidelity Delay), and *2 TAP* (a 2-tap Delay). Press this knob to turn the Delays on and off.

**Knobs 2-6** have the following functions for the various Delay Effects:

Delay	Knob 2 (Time)	Knob 3 (Repeats)	Knob 4 (Param. 1)	Knob 5 (Param. 2)	Knob 6 (Delay Level)
ANALOG	Time	Repeats	--	Multiplier	Delay Level
DM DELAY	Repeat Rate	Echo	Intensity	Multiplier	--
DIGITAL	Time	Repeats	Ducker Threshold	Multiplier	Delay Level
MODULATE	Time	Repeats	Depth	Multiplier	Delay Level
PINGPONG	Time	Repeats	Ducker Threshold	Multiplier	Delay Level
TAPE	Time	Repeats	Wow	Multiplier	Delay Level
ECHOPLEX	Time	Repeats	--	Multiplier	Volume
REVERSE	Time	Repeats	--	Multiplier	Delay Mix
LO FI	Time	Repeats	--	Multiplier	Volume
2 TAP	Time	Repeats	Tap Ratio	Multiplier	Delay Mix

The **Repeats** parameter (Knob 3) ranges from 0 to Repeat Hold (*HOLD*) for all delays except the Echoplex®, DM-2, and Lo-Fi. Repeat Hold is one click past 99, and acts as an infinite repeat.

The **Multiplier** parameter (Knob 5) lets you divide the tap tempo rate into 1/2, 1/4, dotted 1/8, 1/8, and triplet 1/4 note rhythms.

## Reverb

Using reverb in recorded program material gives the listener a sense that the material is being performed in an actual room or hall. It is this similarity to actual acoustic spaces that makes reverberation a useful tool in recorded music. The RP1000 features genuine Lexicon® reverbs, whose rich, lush effects have been heard in countless songs, soundtracks, and live performances for decades.

### Reverb Types

**Knob 1** selects the Reverb Effect or acoustic space. Press this knob to turn the Reverb on and off. The following types are available:

*TWNSPRNG* - Based on a Fender® Twin Reverb      *LEX ROOM* - Lexicon Room  
*LEXAMBNC* - Lexicon® Ambience      *LEX HALL* - Lexicon Hall  
*LEXSTUDD* - Lexicon Studio      *EMTPLATE* - Based on an EMT240 Plate

**Knobs 2-6** have the following functions for the various Reverb Effects:

Reverb	Knob 2 (Pre Delay)	Knob 3 (Decay)	Knob 4 (Liveliness)	Knob 6 (Reverb Level)
<i>TWNSPRNG</i>	--	--	--	Reverb
<i>LEXAMBNC</i>	Pre Delay	Decay	Liveliness	Reverb Level
<i>LEXSTUDD</i>	Pre Delay	Decay	Liveliness	Reverb Level
<i>LEX ROOM</i>	Pre Delay	Decay	Liveliness	Reverb Level
<i>LEX HALL</i>	Pre Delay	Decay	Liveliness	Reverb Level
<i>EMTPLATE</i>	Pre Delay	Decay	Liveliness	Reverb Level

## Section Four - Other Functions

### Expression Pedal

You can link the Expression Pedal on the RP1000 to control the RP1000's Volume, Wah, Whammy™, YaYa™, or almost any of the RP1000's other parameters in real time with your foot. When a parameter has been linked to the Expression Pedal, you can also set the minimum (heel) and maximum (toe) value for the range. When you push down hard on the toe of the Expression Pedal to activate the V-switch, the Expression Pedal switches between the linked parameter and the Wah. To link a parameter to the Expression Pedal, follow these steps:

1. Press either **Edit** button until the Expression row is selected (indicated by the LED lighting on the Expression row).
2. Rotate **Knob 1** until *EXP PEDL* appears in the Display.
3. Rotate **Knob 2** until the desired parameter to be linked appears in the Display.
4. Rotate **Knob 3** to select the minimum (heel) value the assigned parameter will reach with the Expression Pedal in the toe up position.
5. Rotate **Knob 4** to select the maximum (toe) value the assigned parameter will reach with the Expression Pedal in the toe down position.
6. Store your Expression Pedal assignment to your preset. See page 16 for more information on the storing procedure.

### Footswitch Assign

You can link footswitches 6-10 to almost any of the RP1000's parameters or to enable and disable the Amp Loop. From the factory, footswitches 6-10 are set to turn on and off the Compressor, Distortion, Chorus/FX, Delay, and Reverb respectively when the Pedalboard button is enabled. If a parameter other than these on/off parameters is linked to these footswitches, you can specify a minimum value (LED off) and maximum value (LED on) for the parameter. That way you can toggle a parameter like chorus speed between two distinct values while you're performing. Footswitch assignments are stored with the preset so they can be different for every preset. To link a parameter to the footswitches 6-10, follow these steps:

1. Press either **Edit** button until the Expression row is selected (indicated by the Expression row's LED lighting).
2. Rotate **Knob 1** until *F56 ASN - F510 ASN* appears in the Display. This selects which footswitch you are about to change the assignment for.
3. Rotate **Knob 2** until the desired parameter to be linked appears in the Display.
4. Rotate **Knob 3** to select the minimum value the assigned parameter will reach when the footswitch is off (LED off).
5. Rotate **Knob 4** to select the maximum value the assigned parameter will reach when the footswitch is on (LED on).
6. Store your footswitch assignments to your preset.

### LFOs

The RP1000 includes two assignable low frequency oscillators (LFO 1 and LFO 2) that you can assign to any of the same parameters available for assignment to the Expression Pedal. A low frequency oscillator automatically varies the value of the assigned parameter at a steady rate. You can set the minimum and maximum value that each LFO will reach. For instance, if the Amp Gain is assigned to LFO 1, and the minimum value is set to 1 and the maximum value is set to 99, the RP1000 will automatically sweep the amount of distortion from a clean sound to a distorted sound. You can also set the LFO speeds. In the previous example, the LFO speed would determine the length of time it takes the LFO to sweep from the clean to the distorted sound. To assign the LFOs in the RP1000, follow these steps:

1. Press the **Edit** button until the Expression row is selected (indicated by the LED lighting on the Expression row).
2. Rotate **Knob 1** to select one of the two LFO links, LFO 1 (*LFO 1*) or LFO 2 (*LFO 2*).
3. Rotate **Knob 2** to select the parameter you want linked to the LFO 1 or LFO 2.
4. Rotate **Knob 5** to select which waveform you want the LFO to use, Triangle (*TRIANGLE*), Sine (*SINE*), or Square (*SQUARE*).
5. Rotate **Knob 6** to select the speed you want the parameter to be controlled at.

## Wah Min/Max

You can set the Wah effect's minimum and maximum values with the Expression row. To do so, follow these steps:

1. Press the **Edit** button until the Expression row is selected (indicated by the LED lighting on the Expression row).
2. Rotate **Knob 1** to select *WAH PEDL*.
3. Rotate **Knob 3** to adjust the Wah effect's minimum value.
4. Rotate **Knob 4** to adjust the Wah effect's maximum value.

## Expression Update

You can set up the RP1000's Expression pedal to update its position each time you change presets. Normally, the Expression pedal only updates its position on a preset change when it's linked to the Volume Pre or Volume Post parameter in a preset. This lets the Expression pedal behave like a real volume pedal between preset changes. When Expression Update is enabled (ON), the Expression pedal will update its position no matter what parameter it's linked to, so it has more of an "analog" feel like a typical standalone expression pedal.

To enable the Expression Update function, follow these steps:

1. Press the **Edit** button until the Expression row is selected (indicated by the LED lighting on the Expression row).
2. Rotate **Knob 1** to select *EXPUPDAT*. The default setting is for Expression Update is *OFF*.
3. Press **Knob 1** to enable or disable Expression Update.

Expression Update affects all presets. You don't have to save this change to each preset.

## Factory Reset

This function resets the RP1000 to its original factory settings. This procedure erases all custom User presets, and recalibrates the Expression Pedal.

**ATTENTION: Performing this function will erase all user-programmed data. All such data will be lost forever! Be sure you want to erase the memory and start fresh before continuing with this procedure.**

The procedure for performing a Factory Reset is as follows:

1. Press and hold the **Store** button while powering up the RP1000.
2. When the display prompts you with *FACT RST*, release the **Store** button, which is now flashing.
3. Press and hold the flashing **Store** button for 3 seconds until *RESTORE* appears in the display and release. The Restore procedure takes several seconds to complete; during the procedure, the display will count up. After the Restore procedure is complete, the Expression Pedal calibration procedure will begin.

## Expression Pedal Calibration

The Expression Pedal on the RP1000 needs to be recalibrated for use after you do a factory reset. This calibration procedure automatically starts after the factory reset procedure is completed. (You can also start the calibration procedure by pressing and holding the currently active preset's footswitch for about 5 seconds.) If the pedal's calibration fails, or if the pedal does not function properly, it can be re-calibrated using the calibration procedure. This will not erase the User presets. The procedure for calibrating the expression pedal is as follows:

1. Press and hold the currently active preset's footswitch until *PEDL CAL* appears in the display (*BYPASS*, *TUNER*, and *EXIT* will be displayed before *PEDL CAL* is accessed, after about 5 seconds.)
2. When the Display prompts you with *TOE DOWN*, rock the Expression Pedal forward (toe down) and press **Footswitch 5**.

3. When the Display prompts you with *TOE UP*, rock the Expression Pedal back (toe up) and press **Footswitch 5**.
4. The Display now prompts you to calibrate the V-Switch sensitivity (*V SWITCHXXX*), where *XXX* is the current V-Switch threshold. Rock the **Expression Pedal** forward and press firmly on the toe once to turn the V-Switch on (*WAH ON*), and again to turn the V-Switch off (*WAH OFF*).
5. If the V-Switch is too sensitive, press the **Up Footswitch** to raise the threshold (range is 0-199). The **Down Footswitch** decreases sensitivity. Keep testing the V-Switch sensitivity and adjust the threshold until it only engages when you want it to (too sensitive a setting will lead to the V-Switch falsely triggering on or off when using the Expression Pedal).
6. When the V-Switch sensitivity is set to your satisfaction, press **Footswitch 5** to exit.

**Note:** If the Display shows *ERROR*, an error has occurred and steps 2 through 5 should be repeated.

## Preset Level

Each of the presets in the RP1000 can have a specified programmed level. To change the level of a preset, follow these steps:

1. From the preset name display, press the **Edit Down** button once. The Wah row will be lit.
2. Turn **Knob 6** to change the Preset Level parameter.
3. Store these changes to the preset using the Store procedure if these changes are to be recalled later.

## Bypass

Any preset in the RP1000 can be bypassed using the preset footswitches. Bypass will defeat all amp and effects modeling an output an unprocessed bypass signal. Bypass can be selected any time during performance or editing.

1. Press the currently active preset's footswitch. The display will read *BYPASS* and unprocessed guitar signal will be heard on all outputs.
2. Press any footswitch again to exit bypass and return to the last state (edited or unedited) the RP1000 was in.

When a preset is bypassed, any devices connected to the Amp Loop and Stomp Loop will still be active, meaning you can use bypass to kill all effects in the RP1000 without bypassing your core tone.

## Looper

The RP1000 includes a dedicated Looper phrase sampler that lets you record up to 20 seconds of your guitar playing and play it back as an endless loop so you can solo over it. You can also add more guitar work to the recorded loop (overdub). What's great about the RP1000's Looper is that even while the Looper is playing back and/or recording you can select different presets or turn on and off effects to add different sounds to your loop or overdubs.

You turn on the RP1000's Looper with the Looper button in the matrix section and control it with the Up/Down footswitches when the Looper is turned on. You can also connect an FS3X footswitch to the Looper Control input jack on the rear panel for stand-alone remote control of the Looper.

Normally, when the Looper is turned on, the Up/Down footswitches won't change preset banks. However, if an FS3X footswitch is connected to the Looper Control input on the rear panel of the RP1000, the Looper will always be enabled, the Looper button will always be lit, and the RP1000's Up/Down footswitches will always change banks.

There are two ways to use the Looper: with a "quiet start" or "on the fly." "Quiet start" means you activate the Looper's record feature when you're not playing your guitar, and it automatically starts recording when you start playing. "On the fly" means you activate the record feature while you're playing, and it starts recording as soon as you step on the Down footswitch.

To use the Looper with a quiet start, follow these steps:

1. Press the **Looper** button to enable the Looper. The **Looper** button should now be lit. None of the **Record, Play, Overdub** LEDs will be lit at this time.
2. To begin looping, press the **Down** footswitch. The **Record** LED on the matrix will flash red indicating the Looper is armed and ready to record but not actually recording yet.
3. To begin recording, just start playing. The **Record** LED will now light solid red indicating recording is in progress.
4. To set the loop point, press the **Down** footswitch again. The loop point will be set and the recorded phrase will now begin playback. The **Record** LED will turn off and the green **Play** LED will now be lit.
5. To add overdubs to the loop, press the **Down** footswitch again. The yellow **Overdub** LED will now light (the green **Play** LED will still be lit) indicating that anything being played will be merged with the loop being played.
6. Press the **Down** footswitch again to stop overdub recording which will turn off the **Overdub** LED and return the loop to normal playback.
7. To stop loop playback, press the **Up** footswitch. This does not clear out the loop but simply stops playback. Pressing the **Down** footswitch again will resume playback.
8. To clear a loop from memory, press and hold the **Up** footswitch until the main display shows `LOOPCLR`.

To use the Looper on the fly, follow these steps:

1. Press the **Looper** button to enable the Looper. The **Looper** button should now be lit. None of the **Record, Play, Overdub** LEDs will be lit at this time.
2. Start playing your guitar.
3. To begin looping, press the **Down** footswitch. The Looper will start recording as soon as you press the **Down** footswitch, and the **Record** LED on the matrix will light red after about half a second.
4. To set the loop point, press the **Down** footswitch again. The loop point will be set and the recorded phrase will now begin playback. The **Record** LED will turn off and the green **Play** LED will now be lit.
5. To add overdubs to the loop, press the **Down** footswitch again. The yellow **Overdub** LED will now light (the green **Play** LED will still be lit) indicating that anything being played will be merged with the loop being played.
6. Press the **Down** footswitch again to stop overdub recording which will turn off the **Overdub** LED and return the loop to normal playback.
7. To stop loop playback, press the **Up** footswitch. This does not clear out the loop but simply stops playback. Pressing the **Down** footswitch again will resume playback.
8. To clear a loop from memory, press and hold the **Up** footswitch until the main display shows `LOOPCLR`.

If using the optional FS3X to control the Looper, follow these steps for a quiet start:

1. To begin looping, press the **Down** footswitch. The **Record** LED on the matrix will flash red indicating the Looper is armed and ready to record but not recording yet.
2. To begin recording, just start playing. The **Record** LED will now light solid red indicating recording is in progress.
3. To set the loop point, press the **Down** footswitch again. The loop point will be set and the recorded phrase will now begin playback. The **Record** LED will turn off and the green **Play** LED will now be lit.
4. To add overdubs to the loop, press the **Down** footswitch again. The yellow **Overdub** LED will now light (the green **Play** LED will still be lit) indicating that anything being played will be merged with the loop being played.
5. Press the **Down** footswitch again to stop overdub recording which will turn off the **Overdub** LED and return the loop to normal playback.
6. To stop loop playback, press the **Up** (right) footswitch. This does not clear out the loop but simply stops playback. Pressing the **Down** (left) footswitch again will resume playback.
7. To clear a loop from memory, press and hold the **Mode** (left) footswitch until the main display shows `LOOPCLR`.

If using the optional FS3X to control the Looper, follow these steps for on the fly use:

1. Start playing your guitar.
2. To begin looping, press the **Down** footswitch. The Looper will start recording as soon as you press the Down footswitch, and the **Record** LED on the matrix will light red after about half a second.
3. To set the loop point, press the **Down** footswitch again. The loop point will be set and the recorded phrase will now begin playback. The **Record** LED will turn off and the green **Play** LED will now be lit.
4. To add overdubs to the loop, press the **Down** footswitch again. The yellow **Overdub** LED will now light (the green **Play** LED will still be lit) indicating that anything being played will be merged with the loop being played.
5. Press the **Down** footswitch again to stop overdub recording which will turn off the **Overdub** LED and return the loop to normal playback.
6. To stop loop playback, press the **Up** (right) footswitch. This does not clear out the loop but simply stops playback. Pressing the **Down** (left) footswitch again will resume playback.
7. To clear a loop from memory, press and hold the **Mode** (left) footswitch until the main display shows `LOOP CLR`.

## Tuner

The RP1000 features a built-in chromatic tuner with variable tuning references (427-453, A=Ab, A=G, A=Gb). To use the tuner, follow these steps:

1. Press and hold the currently active preset's footswitch to access the Tuner for 2 seconds. The display briefly flashes `TUNER`.
2. To begin tuning, play a note on your guitar (a harmonic at the 12th fret usually works best).
3. The numeric display shows the note being played, and the alpha-numeric display indicates whether the note is sharp or flat. Arrows to the left ( < < < ) indicate the note is sharp and should be tuned down. Arrows to the right ( > > > ) indicate the note is flat and should be tuned up. When your note is in tune, `-> <-` is displayed.
4. To exit the Tuner, press any numbered footswitch.

While the tuner is selected, you can set your tuning reference with Knob 1. The default factory setting is A=440 Hz. The tuning references range from 427 Hz to 453 Hz ( $\pm 50$  cents (1/2 semitone) from either direction of 440 Hz). Below 427 Hz, are alternate dropped tunings. The alternate tunings are REF A (A=Ab), REF G (A=G), and REF G (A=Gb). The display window briefly flashes the selected tuning preference.

## USB Setup

The RP1000 features a USB jack which connects it to a computer. The USB jack serves two purposes: Streaming audio to and from a computer recording software application, and as a connection for use with the X-Edit editor librarian software (downloadable from [www.digitech.com](http://www.digitech.com)).

See [www.digitech.com](http://www.digitech.com) for free X-Edit and driver downloads.

**Note:** PC users must download and install the ASIO driver to use the included Cubase® LE4 recording software.

There are two parameters in the effects matrix for adjusting USB parameters; USB Record Level and USB Playback Mix

**USB Record Level** – This option provides a digital level control for boosting or cutting the level sent to your recording application. Range is -12dB to +24dB.

**USB Playback Mix** – This option controls the playback mix between RP1000 processing and USB playback from your computer's recording application. The range for this control is from USB Mix 0% (all that is heard is the RP1000 processing, no playback) to USB = RP (both USB playback

and RP1000 have equal levels) to RP Mix 0% (all that is heard is the USB playback in the outputs, no RP1000 processing).

To change the USB Setup options, follow these steps

1. From the preset name display, press the **Edit Down** button once to enter Edit mode. The Wah row's LED will be lit.
2. Turn **Knob 4** to adjust the USB Playback Mix.
3. Turn **Knob 5** to adjust the USB Record Level.

Changes made to the USB parameters are saved automatically and will affect the global performance of the RP1000 and all of its presets. Audio recorded via USB in the RP1000 is always tapped off of the audio feeding the XLR outputs.



## Section Five - RPI 000 Effects Descriptions

### **Wahs**

Wah is an effect controlled by an Expression Pedal making the guitar sound as if it's saying "Wah."

#### **DigiTech® Wah**

DigiTech's Full range Wah sweeps the entire spectrum of audible frequencies giving you the most range of tone from the wah pedal.

#### **Dunlop® Crybaby™ Wah:**

This Wah pedal is the more "traditional" sounding Wah pedal that you will have heard in the 60's to the 80's guitar solos. This Wah sweeps the lower to mid range of the audible spectrum.

#### **Vox® Clyde McCoy™ Wah**

This Wah pedal was the "original" and was designed to try to emulate the sound of a muted trumpet. Clyde McCoy was a trumpet player that had asked Vox for a device that could make an instrument sound like his muted trumpet. This Wah has a "thinner" tone and sweeps more of the upper end of the audible spectrum.

### **Compressors**

A Compressor is used to increase sustain, tighten up guitars, and prevent the signal from clipping the input of other effects. It sets a maximum boundary for the strength of a signal.

#### **Boss® CS-2 Compressor/Sustainer**

The CS-2 compresses high-input signals while boosting low-input signals, giving you smooth and long sustain without degrading the quality of the original sound.

#### **DigiTech Compressor**

The DigiTech Compressor compresses high-input signals while boosting low-input signals, giving you smooth and long sustain without degrading the quality of the original sound and also allows you to adjust the tone of the compression.

#### **MXR® Dynacomp**

The MXR® Dynacomp will compress the high-input signals and boost the low-input signals while adding its unique voicing that has become popular with many players for leads, clean chicken picking, and simple boosts.

### **Noise Gates**

A Noise Gate is used to control the volume of an audio signal. In its most simple form, a noise gate allows a signal to pass through only when it is above a set threshold. When this happens, the gate is 'open'. If the signal falls below the threshold no signal is allowed to pass (or the signal is substantially attenuated) and the gate is 'closed'.

#### **DigiTech Silencer Noise Gate**

This noise gate allows you to reduce line noise or audio signal when that signal goes below the set threshold. Depending on how you set the parameters (Threshold, Attack Time, Release, and Attenuation) you can make the audio transition cut your signal at very low noise volumes or high noise volumes.

#### **DigiTech Auto Swell Gate:**

This noise gate will also let you set the threshold of the noise floor but instead of a strict feel of "opening and closing" the gate, you get more of an auto volume swell effect making it a smoother transition between the open and closed positions.

## EQ

The RPI000 is equipped with a 3 band semi-parametric EQ which helps shape your tone with Low, Mid, and High controls.

### 3 Band Semi-Parametric EQ

By adjusting the frequency and levels of each band, you can control how much or little of the frequency range of 60 Hz to 8 kHz you want in your overall tone.

## Chorus Stompbox Models

A Chorus adds a short delay to your signal. The delayed signal is modulated in and out of tune and then mixed back with the original signal to create a thicker sound. The RPI000 includes the following Chorus Effects: Boss® CE-2 Chorus, DigiTech® Dual Chorus, DigiTech Glistening Chorus, DigiTech Multi-Chorus, Electro Harmonix® Small Clone, TC Electronics Chorus, and Voodoo Labs Analog Chorus.

### Boss® CE-2 Chorus

A very simple but popular Chorus pedal. Its simplistic two knob design makes it easy to use adjusting the Speed and Depth of the Chorus while keeping a nice warm tone.

### DigiTech Dual Chorus:

A warm dual voice chorus that allows you to adjust the speed, depth, level, AND wave form. DigiTech Glistening Chorus: A more simplistic Chorus giving you a warm Chorus tone like the CE-2 but adding a 3rd knob allowing you to adjust the overall level as well.

### DigiTech Multi-Chorus

DigiTech's famous Multi-Chorus allows you to get an incredible warm Chorus tone using 16 voices that interact with each other in Stereo Mode giving you the most incredible unique Chorus tone you can imagine.

### Electro Harmonix® Small Clone

A very lush, watery Chorus which can be heard on hits by bands including Nirvana. This Chorus has a very "earthy" tone to it and definitely take your Chorus tone to a different place.

### TC Electronics® Chorus

A Chorus pedal that was made for guitar but also used by Bass and keyboard players as well. Many keyboardists use it to enhance their electric piano "Rhoads" sound. The speed knob controls the speed of the chorus or flanger sweeps. The width knob controls how much frequency change the effect spans. The intensity controls how much of the effect is used.

### Voodoo Labs Analog Chorus

A strikingly vocal with distinct organic tone Chorus pedal. It is capable of a wide range of sounds from a thick analog doubling, to an ultra-lush chorus, and even a Leslie rotating speaker.

## Flanger

A Flanger uses the same principle as a Chorus but uses a shorter delay time and adds regeneration (or repeats) to the modulating delay. This results in an exaggerated up and down sweeping motion to the effect. The RPI000 includes the following Flanger Effects:

ADA Flanger, DigiTech Flanger, DigiTech Filter Flanger, DigiTech Triggered Flanger, Electro Harmonix® Electric Mistress, and the MXR® Flanger.

### A/DA Flanger

A super quiet Flanger with plenty of headroom. Made popular by its ability to get thick and juicy tones from using not only the standard knobs of the normal Flanger but also the Harmonic knob which offers the user a slightly different timbre going from even to odd harmonics.

### DigiTech Flanger

DigiTech's own Flanger model! This gives you the Flanger effect and allows you to control the standard Speed, Depth, Regeneration, and Level of the Flanger effect.

### **DigiTech® Filter Flanger**

The DigiTech tone team expanded on the traditional flanger by adding a band pass filter in the feedback path of the effect. Because of the filter, the filter flanger's feedback affects only a set amount of frequencies to generate a different flanger effect.

### **DigiTech Triggered Flanger**

By setting the threshold sensitivity, you control when the Flanger starts sweeping, and by setting the LFO Start knob, you control WHERE in the sweep it starts! Next you can adjust the speed that it sweeps and the overall level of the Flanger effect!

### **Electro Harmonix® Electric Mistress**

This Flanger has a unique tone giving it a sort of Chorus/Flanger mixed tone making it not as dry as some of the other Flangers (but with a more pronounced sweep). Its easy to use with only 3 knobs (Color, Range, and Rate) which also makes it a little easier to dial in your tone quicker.

### **MXR® Flanger**

A big rich and organic Flanger tone made popular by such people as Eddie Van Halen. The MXR® flanger creates a variety of wild sounds from dynamic jet plane or cool space effects to short delay, chorus and vibrato. Back off Width to zero to disengage auto-sweep, then use the Manual knob to physically place the effect anywhere along the frequency spectrum. Manual knob selects frequency center of effect when auto-sweep is disengaged Width knob at zero disengages auto-sweep, rotates clockwise to increase total phase sweep of effect Speed knob modulates rate of effect Regen knob feeds effect back onto itself at adjustable intensity, increasing the total phase effect.

### **Phasers**

A phaser splits the incoming signal, and then changes the phasing of the signal. This signal is then taken in and out of phase and mixed back in with the original signal. As the phasing changes, different frequencies get canceled resulting in a warm sort of twisting sound. The RP1000 includes the following Phaser types: DigiTech Phaser, DigiTech Triggered Phaser, Electro-Harmonix® Small Stone, and the MXR® Phase 100.

### **DigiTech Phaser**

This Phaser will give you the standard Phaser tone and options for controlling it via the Speed, Depth, Regeneration, and Level settings.

### **DigiTech Triggered Phaser**

Like the Triggered Chorus, You can set the threshold of the sensitivity knob to state what volume you would like the Phaser triggered. Then using the LFO Start knob, you can set where in the range of the Phaser you would like it to start from.

### **Electro-Harmonix® Small Stone**

The Small Stone's full-bodied, 3-dimensional phasing adds a special swirl to every musical style. Blues players dig its rapidly rotating speaker effect while Country players use it to add seasoning to their chicken' pickin'. Metal-heads and Industrialists dig the Stone's jet plane woosh. Its simplistic 2 knob control panel (Rate and Color) make it easier to dial in a quick Phaser tone that will be just right for you!

### **MXR® Phase 100**

Another industry standard in Phase pedals with its own unique tones. It as well has a simplistic 2 knob control panel (Intensity and Speed). Along with the speed control that controls the speed of the Phase sweep, there is the Intensity knob that selects four different intensities, defined as preset waveform patterns. Between the intensity and speed settings, you'll find quite a supply of excellent sounds!

### **Pitch**

The RP1000 comes equipped with effects to manipulate your pitch and do incredible things with it like harmonize both intelligently and by using standard semitones, detune, and do cool effects by raising and/or lowering your original notes from 2 octaves down to 2 octaves up! Pitch pedals it is equipped with are: Boss® OC-2 Octaver, DigiTech Detune, DigiTech Harmony Pitch, DigiTech Pitch Shift, and the ever popular DigiTech Whammy Pedal!!

### **Boss® OC-2 Octaver**

Based on the Boss® OC-2 Octaver™, this adds two signals to your original guitar signal. The first is one octave below your guitar, and the second is two octaves below your guitar. Each additional signal has its own volume control.

### **DigiTech® Detune**

A Detuner makes a copy of your incoming signal, takes the copied signal slightly out of tune from the original, then mixes the two signals together. The result is a doubling type of effect as if two guitars were playing the same part together.

### **DigiTech Harmony Pitch**

Harmony Pitch Shifting makes a copy of the incoming signal, and then changes the pitch of the copied note to a diatonically correct interval specified by the Amount parameter. A Harmony Pitch Shifter sharpens or flattens the shifted pitch in order to keep the specified interval within the selected key and scale creating a true harmony.

### **DigiTech Pitch Shift**

A Pitch Shifter copies the incoming signal, then shifts the pitch of the copy to a different note. The shifted note is then mixed back with the original signal, sounding as if two guitars were playing different notes.

### **DigiTech Whammy™**

The DigiTech Whammy is an effect that uses an Expression Pedal to bend the pitch of the incoming signal, or add a bendable harmony with the original signal. As the Pedal is moved, the note bends either up or down.

## ***Vibrato / Rotary***

### **DigiTech Rotary**

The Rotary is an effect that produces the Doppler effect and volume change of a rotary speaker. The sound is lush and full.

### **DigiTech Vibrato**

The Vibrato produces volume and tone change that can be found on surf and country classics.

### **DigiTech Vibro / Pan**

The Vibro/Pan not only changes volume but shifts it side to side. This effect is great for stereo setups.

### **Unicord Uni-Vibe™**

The Uni-Vibe creates a chorus type effect in tandem with a vibrato to produce a lush swirling effect.

## ***Tremolo***

### **DigiTech Panner**

Pans the sound from side to side. The speed controls how fast and the depth controls how much of the signal is panned.

### **DigiTech Tremolo**

The Tremolo is a volume changing effect that can be heard on surf and country classics.

### **DigiTech ScatterTrem**

The ScatterTrem combines two tremolos that are “out of sync” to produce an unpredictable scattered tremolo sound.

### **Fender® Opto Tremolo™**

The sound of the Fender® Opto Tremolo is as classic as their amps. Both tone shift and volume effects are produced to create this unique tone.

### **Vox® Bias Tremolo**

Another way to achieve a tremolo effect is to alter the bias of the poweramp tubes. This Vox® Bias Tremolo produces the volume and tone effects to create a tone heard on many famous British tunes.

## ***Envelope / Special***

### **DigiTech® Envelope Filter**

An envelope filter is also called a “auto-wah” for its wah effect. The amount of wah is dependent of the output volume of your guitar – the harder you play, the more wah you get. A definite B-Movie soundtrack tone.

### **DigiTech Auto Wah™**

If a wah, why not an effect that says “yah” when you use it? This is another take on the vowel based effects but it is controlled the same way that the envelope filter is controlled.

### **DigiTech Sample & Hold**

Using a changing filter, the Sample and Hold produces skipping tones that can be heard in experimental and alternative music. Best used with distortion in front of the effect.

### **DigiTech Step Filter**

The Step Filter changes frequency in related patterns much like a sample and hold effect.

### **DigiTech Synth Talk™**

Another DigiTech first, the Synth Talk™ makes your guitar sound like it's talking due to vowel like qualities.

### **DigiTech Ya Ya™**

A descendent of a wah, the YaYa™ is a more complex circuit that produces a “ya” sound.

### **DOD® FX25 Envelope Filter**

The DOD® FX25 is an classic analog envelope filter that can be found on many funk and alternative tracks. Used by both guitar and bass players. Try this one clean for a really funky sound.

## ***Delays***

### **Analog Delay**

The analog delay produces delays that were derived from “BBD” analog delay chips. The BBD chips were the first ways to produce delay aside from the costly tape delays. The delay sound was not HiFi but was reminiscent of the original signal and quickly became a cornerstone to modern guitar sounds due to their warm qualities.

### **Boss® DM2 Analog Delay:**

The DM2 is a classic and standard BBD analog delay that used 4,096 stages of delay. The frequency response and noise depended upon the delay time. The signal derogates with every repeat so as the repeats are turned up, the signal becomes less and less recognizable and actually becomes more of an “effect” than a delay.

### **Digital Delay**

A digital delay can be called a perfect representation of your guitar's signal. Desired for their brilliant qualities, digital delays have virtually no noise and a full frequency response.

Lo Fi Delay: The Lo Fi delay is an analog delay with a severely limited frequency response to produce an even grungier delay effect.

### **Maestro EP-2 Tube Echoplex**

The Echoplex is the standard to which all analog delays are judged. The Echoplex was the first widely used tape delay and had a tone all of it's own. The Echoplex can be heard on many rockabilly, surf, country and rock tracks.

### **Modulated Delay**

A modulated delay is a digital delay with chorus added to the delays to produce a wider sounding stereo delay.

### **Pong Delay**

A pong delay's repeats jump from side to side and requires a stereo setup.

**Reverse Delay:** The Reverse Delay senses the guitar's input signal and plays the delayed guitar backwards once it is sampled. Reverse delay used to be a studio trick, now with modern technology it exists in a stompbox!

### **Tape Delay**

The tape delay effect produces a warm tone by limiting the frequency response and adding the distortion that exists in a tape delay.

### **2-Tap Delay**

While most delays are derived from a signal delay with one end tap, the 2-Tap Delay uses a single delay line but with two endpoints that are spaced about at different ratios. Use this effect to add more of a rhythmic quality to your delays.

## **Reverbs**

### **EMT® 240 Plate Reverb**

The EMT Plate Reverb is the reverence reverb to which all studio reverbs are compared to. Using a large sheet of metal, one end of the "plate" was excited by a transducer and the sound would then travel through the plate to the other side where the delayed tone was received. The frequency response and dynamics of the signal would change when traveling through the plate creating a reverb effect.

### **Lexicon® Ambience**

The Lexicon Ambience reverb is full, bright and produces ambience around or behind your guitar signal.

### **Lexicon Hall**

The largest of the Lexicon reverbs, the Hall produces lush reverbs with a swirling decay unlike any other reverbs today.

### **Lexicon Room**

A great effect to produce a small room, the Lexicon Room produces that reverb found in many isolation rooms in recording studios today.

### **Lexicon Studio**

Larger than the Room reverb, the Studio Reverb is the Lexicon studio standard reverb algorithm.

### **Spring based on a Fender® Twin Reverb™**

The tone and reaction of the spring reverb is captured! Surf's up, the best setting is at maximum - Cowabunga.

## **Distortions**

Distortion and overdrive pedals were designed to give your guitar tone gain before it reaches your amp. Many heavily distorted pedals such as the DigiTech Grunge™ were designed to provide most or all of the gain and run through a cleaner amp. Overdrives are great for boosting the gain of your guitar sound and driving an already distorted amp giving your total tone, more gain and a heavier feel. Overdrives on their own and ran into clean amps provide a bluesy tone.

### **Arbiter® Fuzz Face™**

The Dallas Arbiter Fuzz Face surfaced in 1966 and used germanium transistors to get it's unique fuzzy sound and inspired many other fuzz pedals to follow. The Fuzz Face produces a thick wall of edgy distortion and a very full low end. Perfect for creating '60s or modern stonerrock tones.

---

### **Boss® DS-1™ Distortion**

A truly classic distortion. A nice, common distortion that ranges in tone from rock to mild metal. Use it to drive a distorted amp!

### **Boss MT-2 Metal Zone®**

The Metal Zone will produce nearly any metal tone needed from tight, percussive Bay area thrash to deep detuned grind core.

### **Boss OD-1 Overdrive**

The OD-1 is perfect for just adding a little gain to your tone no matter what type of amp you use. To produce a bluesy tone, use it with a clean combo. To drive your stack, crank the gain and level.

### **Boss SD-1 Overdrive**

With a little more gain than the OD-1, the SD-1 will drive any amp into another realm. If you're just looking for a good classic rock tone, this is it.

### **Demeter Fuzzulator**

Enhancing the proper frequencies with a pre-emphasis tone circuit, the Fuzzulator produces distortion that is unique and does not get muddy. It just gets better and the Fuzz is turned up.

### **DigiTech® Amp Driver**

The Amp Driver distortion is designed to turn a regular distorted amp into a monster. The Amp Driver not only distorts the guitar's signal but also boosts frequencies around 600Hz. By emphasizing the frequencies around 600Hz amps can be driven harder and take on more of a metal tone. A mean sound is not only how determined by how much gain you put in front of your amp, but how hard you drive the amp and with what frequencies the amp is driven with.

### **DigiTech Death Metal™**

Designed in 1992 to provide death metal musicians with a wall of sound, the Death Metal™ pedal does just that. Whether you play early '90s grindcore or modern death metal, the Death Metal's tone controls that are placed at the correct frequencies give you a multitude of sonic options.

### **DigiTech Grunge®**

In late 1991 as Grunge hit the radio the pedal was designed as the DOD FX69 Grunge. The pedal was designed by a young engineer who played "punk" and was released as an experiment to see what this "new type" of music was all about. Now a decade later, the Grunge is still a top-seller. The Grunge produces tones from early famous Seattle sounds to borderline metal. Don't forget your flannel....

### **DigiTech Redline Modified Overdrive**

Not your standard overdrive, the Redline takes overdrive to a place that never existed. The Redline's circuit overdrives the guitar's signal in a way that is not evenly clipped like the way a tube amp distorts. Add extra gain and a thicker low end and the Redline was born.

### **DOD 250 Overdrive/Preamp**

The DOD®250 is another classic overdrive. With no tone control to get in the way, the 250's beauty is just it's pure overdrive.

### **DOD Classic Fuzz**

A part of the original DOD FX family, the Classic Fuzz gained a following for its clearer voicing as compared to many fuzz pedals.

### **DOD Gonkulator Ring Modulator**

Meet the needs of many experimental guitarists, the Gonkulator was a silent hit only to become a high cost internet item. The Gonkulator is a combination of a Grunge pedal and a ring modulator that produces distortion and mixes in bell-like ringing. The first pedal with a "suck" knob.

### **Electro-Harmonix® Big Muff Pi®**

A requirement for any alternative player, the Big Muff Pi's thick fuzz is unmistakable in grunge, new wave and many punk hits.

### **Fulltone® OCD Overdrive**

Straddling the border of overdrive and distortion, the OCD produces amazing harmonics and drives any amp into oblivion. The overdrive is thicker than most yet clear letting every string and note come through.

### **Guyatone® Overdrive OD-2**

The OD-2 is yet a different flavor of overdrive. The OD-2's is transparent and does not get in the way when playing single notes or chords.

### **Ibanez® TS-9 Tube Screamer™**

One of the most famous pedals ever created, the TS-9 has not only stood the test of time but can be found on nearly every pedal board.

### **Ibanez TS-808 Tube Screamer™**

The predecessor to the famed TS-9 the TS-808 has spawned a whole boutique market around modifications to this classic design. If you want one of the standards in overdrive, this is it.

### **Modified Ibanez® TS-9**

Take a TS-9, add more gain and modify the low end to produce a thicker, bluesier overdrive.

### **MXR® Distortion +**

A classic pedal due to its simplicity. Just plug in and go. The Distortion + produces good honest distortion, perfect for driving a distorted amp.

### **Pro Co RAT™**

Want gain? Want more gain? The Rat was one of the first pedals to take the gain to another dimension. The filter control gives the Rat its unique tones and flexibility. It is rumored that early Bay area thrash bands used it in conjunction with a Marshall® JCM800 to achieve their heavy tones.

### **Roger Mayer Octavia™**

Designed in 1967, the Octavia was featured on "Purple Haze" and "Fire" by Jimi.

### **Voodoo® Lab Sparkle Drive®**

The Sparkle Drive mixes a 808 tone with boosted clean to form a perfect device to drive amps.

## **Amps**

### **'99 Carvin® Legacy VL-100**

Steve Vai's signature amp that he has been using since 1999. Custom tweaked tone to Steve's specifications featuring an EL-34 tube output stage. Very smooth for soloing.

### **'57 Fender® Tweed Champ®**

The Tweed Champ is a straight ahead, growly amp with that is best suited for blues and garage music. The tone is nasely, distorts easy due to the low wattage but cuts through!

### **'57 Fender Tweed Deluxe™**

One of the most sought after amps ever made, this is a tone you can't get enough of. This baby shows off its glory when pushed to the limits.

### **'59 Fender Tweed Bassman®**

This classic really roars with lots of bottom end. Great for blues riffs but equally great for driving rock and roll rhythm guitar parts.

### **'62 Fender Brownface Bassman®**

From the era of the first tolex covered Fender® amps, this particular amp was used on the classic Hendrix song "Voodoo Child".

### **'65 Fender Blackface Twin Reverb®**

The benchmark for twin speaker combos. This great amp is one of the most recognizable clean tone on recordings for the last 40 years.



---

### **'65 Fender® Blackface Deluxe Reverb®**

The single speaker version of its bigger brother, this amp is equally at home for blues, country and rock players.

### **'59 Gibson® GA-40**

A very cool blues/rock amp in the ranks with the Deluxes but with a personality all its own.

### **'69 Hiwatt® Custom 100 DR103**

This superb rock and roll amp was the staple of Pete Townshend's tone in the early /70s. A monster that has loads of headroom, this is at its best when cranked up all the way and paired with the Fane 4x12 cab.

### **'69 Laney™ Supergroup**

The Supergroup was used most notably by Tony Iommi and was key to the sound of early Black Sabbath records.

### **'65 Marshall® JTM-45**

Perhaps the turning point for blues and rock and roll, this amp set the course for the future of Marshall® amps. It started the "crunch" revolution, turning up on classic songs from AC/DC and most notably the Bluesbreakers "Beano" album featuring Eric Clapton.

### **'68 Marshall 100 Watt Super Lead (plexi)**

This is undoubtedly the amp that changed rock and roll. It is a benchmark for many of the greatest guitar sounds ever heard. From Hendrix to Van Halen, this amp is the real deal.

### **'68 Marshall Jump Panel**

This is the method to get the most saturation from the classic plexi. By jumping channel 1 into channel 2, you get a bit more push over the top.

### **'77 Marshall Master Volume**

This amp was king of rock and roll in the 70's and one of our favorites. This JMP 100W amp featured four 6550 output tube making it hot and punchy for rock and punk music alike.

### **'83 Marshall JCM800**

The amp that defined many of the metal sounds of the 80's is still one of the most highly respected Marshall® amps ever made.

### **'93 Marshall JCM900**

Incorporating a diode clipping stage, this amp gives you more gain than you can shake a stick at.

### **'01 Marshall JCM2000 (Solo Channel)**

The TSL100 is a superb tone with tons of sustain for grinding riffs or singing solos.

### **'81 Mesa Boogie® Mark II C**

Based originally off hot rodded Fender® amps, this classic has some of the best rhythm and lead tones ever. This amp was the peak for Mesa Boogie during their custom built to order days.

### **'86 Mesa Boogie .22 Caliber**

A monster little combo with the classic Boogie Mark tone.

### **'93 Mesa Boogie Mark IV**

If high gain is your bag, this is up your alley. Still a hugely influential amp today as it was when introduced over a decade ago.

### **'96 Mesa Boogie Dual Rectifier**

The new benchmark for metal guitar, this mid 90's Rectifier series unleashed a new era of high gain amp mayhem.

### **'01 Mesa Boogie Triple Rectifier**

The latest from the guys in Petaluma, this bigger brother of the dual rectifier packs and additional 50 Watts of power.

**'95 Matchless™ Chieftain**

A beautifully full amp tone with plenty of character. The Chief is a really great amp to use for putting a slightly different color in your musical palette.

**'96 Matchless HC30**

The perfect Class A crunch tone with tight responsive low end. This is right at home with country, blues, and rock

**'74 Orange™ OR 120**

This often overlooked amp from a great British amp company was used by greats like Jimmy and Frank Zappa. No wonder the great Orange is making a comeback.

**'99 Peavey® 5150® II**

Designed in conjunction with Eddie Van Halen by Peavey®, this amp offers gain for days.

**'88 Randall® HT-100**

A vintage solid state amp that ushered in a new metal generation. This was the amp Dimebag used in the earlier Pantera days.

**'84 Roland® JC-120**

This solid state combo was synonymous with the sparkling clean sounds of the 80's.

**'88 Soldano SLO-100**

Considered one of the first "boutique" amp companies, the SLO 100 is a pure gain head's dream. Smooth distortion with incredible sustain, this amp is amazing.

**'67 Sunn® 100S**

Used by Pete Townshend in the late '60s US tour, these amps offered tons of headroom which certainly delivered the SPLs The Who loved.

**'62 Vox® AC15**

The first great Vox® amp. A single 12" version of its more famous 30 Watt big brother, this amp has much of the same character to offer.

**'63 Vox AC30 Top Boost**

The quintessential amp that defined both Brian May's and Edge's sound. Just crank this amp up and get some of the most awesome growl you will ever hear from an amp.

**DigiTech® Blackbass – '65 Blackface preamp w/ Bassman poweramp**

What happens when you combine the cleaner input stage of Blackface and connect it to the gritty poweramp of a Bassman? You get an experimental amp that works perfect for blues, rock-a-billy, country and rock. You'll want to drive this hard.

**DigiTech Blues**

A perfect combination of clarity and grit. The Blues amp cuts through but doesn't get too muddy as the gain is turned up.

**DigiTech Bright Clean**

A perfect clean combo amp structure, the amp is bright yet cleaner than most. Great for jazz, surf, country, clean rock and metal.

**DigiTech Brownsound - Hot rodded 80's stack tone**

The Brownsound is a hot-rodded Marshall® tone of the early '80s made famous by a wild, finger-tapping guitarist.

**DigiTech Chunk**

Thicker than a Marshall®, the Chuck gives you lots of gain with plenty of low end that doesn't get in your way.

**DigiTech Clean Tube**

The Clean Tube is a very clean tube combo tone with just the right amount of 2nd harmonics.



---

### **DigiTech® Crunch**

The Crunch is just that, a tube head that crunches more than the rest. The crunch has extra gain and cuts through. Perfect for both rhythms and solos.

### **DigiTech Tweedface – Tweed preamp w/Blackface poweramp**

Imagine combining two of the greatest Fender® amps into a single beast. That's what we have done with the Tweedface. Take the preamp of the classic Tweed Deluxe™ and combine it with the output stage of the Blackface Twin Reverb® and here is the monster you get.

### **DigiTech Darkmetal**

Producing a tight, focused tone, the Darkmetal has high gain, yet does not muddy up your guitars tone. Perfect if you play intricate metal.

### **DigiTech Fuzz**

The DigiTech Fuzz tone is based off of the fuzz tone of the late 60's English bands with our own twist with fizz. Thus making the DigiTech Fuzz ideal for 90's grunge to today's mix of music.

### **DigiTech GSP2101™ Artist Clean Tube**

The GSP2101 has become an iconic preamp processor for many players over the years. After years of requests from players, we have brought the sounds back from their glory days. The GSP2101 Clean Tube captures the warmth and brightness while being able to drive it hard to produce a nice warm clean sound with grit.

### **DigiTech GSP2101 Artist Saturated Tube**

The sound of the GSP2101 preamp being the most used sound from the GSP2101. Mild to over the top gain without getting a muddy sound. A perfect tone setting for all types of music.

### **DigiTech High Gain**

For the rock or hard rock player who requires a lot of distortion as a starting point. A very punchy tone for both rhythm and lead work reminiscent of a well polished production album.

### **DigiTech Metal**

A true metal tone for both classic or modern style metal with a chunky bottom end. This setting is able to achieve a variety of metal tones with the use of the EQ and gain controls.

### **DigiTech Monster**

The DigiTech Monster was created on an operating table in a European castle with one thing in mind, full-on dimed out molten metal gain. This is the perfect setting for death metal or the Norwegian Sound.

### **DigiTech Mosh**

This sound was created after the mid 80's NYC and Bay Area tones. You will feel like you're in the pit while taken a "thrashing." Big metal sound with a bit of sizzle.

### **DigiTech Solo**

Dialed in tone ideal for laying down solos for country, rock, jazz, blues and even metal. Add a bit of delay and reverb, and you have the perfect sound for any lick you can come up with.

### **DigiTech Spank**

A bright and punchy clean sound that can be driven for a bit of edge. At home with funk or any tone that needs some spanking.

### **DigiTech Stonerrock**

The Stonerrock amp produces tones made famous by So-Cal and desert bands. The Stonerrock's huge, flubby low end and warm high end make you want to use your bridge pickup, turn your guitar's tone knob down and play Godzilla all night.....

### **DigiTech Transistor**

The Transistor setting emulates a grainy narrow EQ band sound of a solid state transistor lo-fi amplifier. Great for use as an effect or to set the mood.

## **Direct**

No amp model

## **Dreadnaught Acoustic**

Awesome dreadnaught acoustic simulation with an articulate top end. Best suited for middle and neck pickups.

## **Jumbo Acoustic**

A warmer acoustic model with more midrange.

## **Cabinets**

### **1x8 '57 Fender® Tweed Champ®**

A small speaker but a great way to cut through the mix.

### **1x12 '57 Fender Tweed Deluxe®**

A bluesman's delight. Wonderful response with a classic tone when matched with its namesake amp model.

### **1x12 '65 Fender Blackface Deluxe Reverb®**

Solid tone can be combined with any amp for a great rhythm tone.

### **1x12 '62 Vox® AC15**

A great little cab perfect for rock and blues.

### **1x12 '59 Gibson® GA-40**

Similar to the Deluxe cabs with emphasized top end for more bite.

### **2x12 '57 Fender® Blonde Bassman®**

Warm dual speaker combo. Great for driving rhythm playing or clean chord comps.

### **2x12 '65 Fender Blackface Twin Reverb®**

The benchmark that many others have tried to imitate. The classic clean tone at it's best.

### **2x12 '63 Vox AC30 Top Boost w/ Jensen® Blue Backs**

Amazing low end. These were our favorite speakers of the early Vox/Jensen era.

### **2x12 '84 Roland® JC-120**

Awesome for spankin' clean tones with emphasized top end.

### **2x15 '68 Sunn 200S w/JBL®-Lansings**

Powerful bottom end from a landmark speaker designer. Classic tones from the late '60s.

### **4x10 '59 Fender Tweed Bassman®**

Powerful, throaty, and just plain cool. This mixed with its matching amp get you tones as cool as they come.

### **4x12 Hiwatt® Custom w/ Fane Speakers**

Unique warm tone was the perfect balance for the head it is originally paired with.

### **4x12 Marshall® 1969 Straight w/ Celestion® G12-T70**

Great power handling speakers give you the classic Marshall® bite and chunk. Takes a lot of power to break these up.

### **4x12 Marshall 1969 Slant w/ Celestion® 25W Green backs**

Super speaker design provides a voice that is distinctive as it's name. Great match for the Plexi.

### **4x12 '96 Johnson® Vintage w/ Celestion® Vintage 30's**

Classic V30 sound with throaty midrange and great low end.



---

### **4x12 '96 VHT® Slant w/ Celestion® Vintage 30's**

A rare matchup from the guys at VHT. Great bite that really cuts through.

### **4x12 '07 Mesa/Boogie Rectifier w/Celestion® Vintage 30's**

The ultimate 4x12 for the heaviest tone. Massive bottom end and punchy midrange.

### **2x12 DigiTech® Bright**

A particularly bright but full sounding combo cabinet. Great for clean.

### **4x12 DigiTech Alt Rock**

The DigiTech Alt Rock is a dirtier cabinet with more sizzle than a standard 4x12 cabinet. Use if you want to drive your tone over the edge.

### **4x12 DigiTech Chunk**

The Chunk is a thicker cabinet that lends itself to hard rock and solos. This will help any amp cut through the mix.

### **4x12 DigiTech Metal**

The Metal cabinet provides a deeper but tight low end response. Great with any amp that needs a little focus.

### **4x12 DigiTech Rock**

Take a standard 4x12 and add just a little more 600Hz to cut through the mix, the Rock cabinet not only sounds good for rock but excels at hard rock and gives distorted combos new life.

### **4x12 DigiTech Solo**

One issue with solos, the need to cut through and not squash the sound. The Solo cabinet is phrased to provide clear tone with maximum distortion.

### **4x12 DigiTech Spank**

Need a jangly, funk high end? The Spank is perfect for funk.

### **4x12 DigiTech Speaker Compensation**

The speaker compensation is from the GSP2101. The has become a standard in direct micing for music of all types.

### **4x12 DigiTech Vintage**

A vintage speaker cabinet with that "broken in" warm tone.

### **4x12 Johnson® Straight w/ Celestion Vintage 30's**

This tone is great when used for rock, hard rock and metal. The low end compresses just the right amount due to the combination of the Celestion Vintage 30's and cabinet volume.

### **Direct**

No cabinet model

# Section Six - Appendix

## Specifications

### General Specifications

A/D/A Converter:	24-bit high performance audio
Sample rate:	44.1 kHz 24 bit
DSP Section:	AudioDNA2™ DSP Processor
Voltage Rails:	+/-15V
Electronic SNR:	≥ 107dB
USB:	2.0 compliant
Audio streaming:	2 channels to computer; 2 channels from computer
Simultaneous Effects:	10
Preset Memory:	100 User Presets (1-00) / 100 Factory Presets (F1-F00)
Dimensions:	19.5" Length x 10.75" Width x 3.75" Height
Unit Weight:	11.5 lbs.

### Analog Input Connections

#### Guitar Input

Impedance:	1M Ohms
Maximum Input signal:	8 dBu

#### Stompbox Loop Input

Impedance:	475K Ohms
Maximum Input signal:	8 dBu

#### Amp Loop Input

Impedance:	16K Ohms
Maximum Input signal:	8 dBu

### Analog Output Connections

#### Line Outputs

Impedance:	1K Ohms unbalanced / 2K Ohms balanced
Maximum Output level:	8 dBu

#### XLR Mixer Outputs

Impedance:	2k Ohms balanced
Maximum Output level:	14 dBu

#### Stompbox Loop Output

Impedance:	600 Ohms unbalanced / 1.2K Ohms balanced
Maximum Output signal:	8 dBu

#### Amp Loop Output

Impedance:	600 Ohms unbalanced / 1.2K Ohms balanced
Maximum Output signal:	8 dBu

#### Headphone Output

Minimum Headphone Impedance:	50 Ohms
------------------------------	---------

#### External Control Input

Looper Footswitch Input:	for use with optional DigiTech FS3X
--------------------------	-------------------------------------

### Power Requirements

Power Supply:

**\*Important Note:** There are two different models of this product. If purchasing a replacement power supply, ensure that you properly match the power requirements screening on the back panel of the product with the corresponding adapter model listed below.

#### 9 VAC 1.3 A\*

Country	Voltage	Adapter Model
Japan:	100 VAC, 50/60 Hz	PS0913B-100*
US and Canada:	120 VAC, 60 Hz	PS0913B-120*
Europe:	230 VAC, 50 Hz	PS0913B-230*
UK:	240 VAC, 50 Hz	PS0913B-240*
Australia:	240 VAC, 50 Hz	PS0913B-240-AU*

#### 9 VDC 1.3 A\*

Country	Voltage	Adapter Model
US, Canada, Europe, Japan:	100-240 VDC, 50/60 Hz	PS0913DC-01*
Australia & UK:	100-240 VDC, 50/60 Hz	PS0913DC-02*



## Windows® Software Requirements

Vista Home/Premium, XP Home/Professional (SP2 installed, .NET 2.0 installed\*)  
Pentium®/Athlon™ 1.4GHz or later 512MB RAM (1GB RAM recommended)  
180MB hard disk space for application  
DVD-ROM drive  
USB Port

Internet connection required for Cubase activation

\*.NET 2.0 will be installed during installation of X-Edit software if required on XP systems

## Mac® Software Requirements

OS 10.4.x or later  
PowerPC G4/G5 1GHz or later  
512MB RAM (1GB RAM recommended)  
180MB hard disk space for application  
DVD-ROM drive  
USB Port  
Internet connection required for Cubase activation

## Tone Library

OVERDRIVE	COUNTRY 2	BRITISH 2
DISTORTION	WARM DRIVE	AMERICAN 1
HOT RAT	CRUNCH	AMERICAN 2
SUSTAINER	TEXASTONE	TUBE DRIVE
FUZZOH	ROCKABILLY	SCOOPED
OVEREASY	SOLO 1	PUNCHY
DIRTY TUBES	SOLO 2	BRIGHT CLEAN
ROCK 1	ROCK WAH	BIG PUNCH
ROCK 2	CHUNKY	SUPER GAIN
BLUES 1	SMOOTH	GRINDER
BLUES 2	HEAVY	BAD BOY
METAL 1	CLEAN 1	LEGACY LEAD
METAL 2	CLEAN 2	
COUNTRY 1	BRITISH 1	

## Effects Library

CUSTOM/CHORUS	SPRING REVERB	TREMOLO-TAPE DELAY
PHASER	CHORUS-DELAY	PITCH-DELAY
FLANGER	CHORUS-DLEAY-REVERB	MOD DELAY-PLATE REVERB
PITCH	FLANGER-DELAY	ROTARY-DELAY
TREMOLO	PHASER-DELAY	ENVELOPE-REVERB
ROTARY	PHASER-MOD DELAY	VIBRO-DELAY
ENVELOPE FILTER	PHASER-REVERB	ROTARY-DELAY-SPRING
DIGITAL DELAY	DIGITAL DELAY-REVERB	SLOW SWEEP
ANALOG DELAY	DELAY-SPRING REVERB	VIBROPAN
PONG DELAY	CHORUS-REVERB	VIBE-DELAY
MODULATED DELAY	PONG DELAY-HALL RE-	OCTAVE ROOM
TAPE DELAY	VERB	A MAJOR
HALL REVERB	TAPE DELAY-SPRING RE-	TRIPLET DELAY
PLATE REVERB	VERB	SPACIOUS

DigiTech®  
8760 South Sandy Parkway  
Sandy, Utah 84070  
PH (801) 566-8800  
FAX (801) 566-7005  
<http://www.digitech.com>

DigiTech® is a registered trademark  
of Harman

Copyright - Harman

Printed in China

RP1000 Owner's Manual 18-0597V-D



Disclaimer: DigiTech, X-Edit, Production Modeling, Grunge, Death Metal, Jimi Hendrix™ Artist Series Pedal, DOD, Gonkulator, DigiTech Whammy, Multi Chorus, Auto Ya, Ya Ya, Synth Talk, Lexicon, Johnson Amplification and AudioDNA are trademarks of Harman. \*Other product names modeled in this product are trademarks of their respective companies that do not endorse and are not associated or affiliated with DigiTech or Harman. ADA Flanger, Arbiter Fuzz Face, Boss CE-2 Chorus, Boss CS-2, Boss DM-2, Boss DS-1, Boss Metal Zone, Boss OC-2 Octaver, Boss OD-1, Boss SD-1, Celestion, Carvin Legacy, Demeter Fuz-zulator, Dunlop Cry Baby, EH Big Muff ?, EH Electric Mistress, EH Small Clone, EH SmallStone, EMT 240 Plate, Fender Blackface Deluxe Reverb, Fender Blackface Twin Reverb, Fender Blonde Bassman, Fender Brownface Bassman, Fender Opto Tremolo, Fender Tweed Bassman, Fender Tweed Champ, Fender Tweed Deluxe, Fender Twin Reverb, Fulltone OCD Overdrive, Gibson GA-40, Guyatone Overdrive, Hiwatt, Ibanez Tube Screamer, Jensen Blue Backs, Laney Supergroup, Maestro EP-2, Marshall, Marshall JTM-45, Marshall JumpPanel, Marshall Master Volume, Marshall SuperLead, Matchless, Matchless Chieftain, Mesa/Boogie, .22 Caliber, Mark II, Mark IV, Dual Rectifier, Triple Rectifier, MXR, MXR Distortion +, MXR DynaComp, MXR Flanger, MXR Phase 100, Orange ORI 20, Peavey 5150, ProCo Rat, Randall HT-100, Roger Mayer Octavia, Roland JC-120, Soldano, Sunn 100S, TC Electronic Chorus, Unicord Uni-Vibe, VHT Amplification, Voodoo Labs Analog Chorus, Voodoo Labs Sparkle Drive, Vox, Vox Bias Tremolo, Vox Clyde McCoy Wah, and Vox Top Boost are trademarks or trade names of other manufacturers and were used merely to identify products whose sounds were reviewed in the creation of this product. All other trademarks are the property of their respective holders. Copyright - Harman. All rights reserved.